

Royal Canal Greenway Cycle And Pedestrian Route Phase 4 Phibsborough to Ashtown - Amending Part VIII

CIVIL WORKS

DRAWING TITLE	DRAWING No.	
SITE LOCATION MAP		
SITE LOCATION MAP	KEY PLAN	RCP4-RODA-GEN-4B_AE-DR-CH-400000
SITE LOCATION MAP	SHEET 1 OF 6	RCP4-RODA-GEN-4B_AE-DR-CH-400001
SITE LOCATION MAP	SHEET 2 OF 6	RCP4-RODA-GEN-4B_AE-DR-CH-400002
SITE LOCATION MAP	SHEET 3 OF 6	RCP4-RODA-GEN-4B_AE-DR-CH-400003
SITE LOCATION MAP	SHEET 4 OF 6	RCP4-RODA-GEN-4B_AE-DR-CH-400004
SITE LOCATION MAP	SHEET 5 OF 6	RCP4-RODA-GEN-4B_AE-DR-CH-400005
SITE LOCATION MAP	SHEET 6 OF 6	RCP4-RODA-GEN-4B_AE-DR-CH-400006

SITE NOTICE LOCATION		
SITE NOTICE LOCATION	KEY PLAN	RCP4-RODA-GEN-4B_AE-DR-CH-400200
SITE NOTICE LOCATION	SHEET 1 OF 3	RCP4-RODA-GEN-4B_AE-DR-CH-400201
SITE NOTICE LOCATION	SHEET 2 OF 3	RCP4-RODA-GEN-4B_AE-DR-CH-400202
SITE NOTICE LOCATION	SHEET 3 OF 3	RCP4-RODA-GEN-4B_AE-DR-CH-400203

GENERAL ARRANGEMENT		
KEY PLAN	KEY PLAN	RCP4-RODA-GEN-4B_AE-DR-CH-400100
SITE LAYOUT PLAN	SHEET 1 OF 4	RCP4-RODA-HGN-4B_AE-DR-CH-400001
SITE LAYOUT PLAN	SHEET 2 OF 4	RCP4-RODA-HGN-4B_AE-DR-CH-400002
SITE LAYOUT PLAN	SHEET 3 OF 4	RCP4-RODA-HGN-4B_AE-DR-CH-400003
SITE LAYOUT PLAN	SHEET 4 OF 4	RCP4-RODA-HGN-4B_AE-DR-CH-400004

DRAWING TITLE	DRAWING No.	
TYPICAL CROSS SECTIONS		
TYPICAL CROSS SECTIONS	RCP4-RODA-HGN-4B_AE-DR-CH-400300	
ENERGY RESILIENCE INFRASTRUCTURE		
ENERGY RESILIENCE INFRASTRUCTURE	RCP4-RODA-UES-4B_AE-DR-CH-400500	
JOINT BAY TYPICAL CROSS SECTIONS	SHEET 1	RCP4-RODA-HML-4B_AE-DR-CH-400101
JOINT BAY TYPICAL CROSS SECTIONS	SHEET 1	RCP4-RODA-HML-4B_AE-DR-CH-400102

LANDSCAPING		
LANDSCAPING	SHEET 1	RCP4-RODA-ELS-4B_AE-DR-CH-403101
LANDSCAPING	SHEET 2	RCP4-RODA-ELS-4B_AE-DR-CH-403102
LANDSCAPING	SHEET 3	RCP4-RODA-ELS-4B_AE-DR-CH-403103
LANDSCAPING	SHEET 4	RCP4-RODA-ELS-4B_AE-DR-CH-403104
LANDSCAPING	SHEET 5	RCP4-RODA-ELS-4B_AE-DR-CH-403105
LANDSCAPING	SHEET 6	RCP4-RODA-ELS-4B_AE-DR-CH-403106
LANDSCAPING	SHEET 7	RCP4-RODA-ELS-4B_AE-DR-CH-403107
LANDSCAPING	SHEET 8	RCP4-RODA-ELS-4B_AE-DR-CH-403108
LANDSCAPING	SHEET 9	RCP4-RODA-ELS-4B_AE-DR-CH-403109
LANDSCAPING	SHEET 10	RCP4-RODA-ELS-4B_AE-DR-CH-403110
LANDSCAPING	SHEET 11	RCP4-RODA-ELS-4B_AE-DR-CH-403111
LANDSCAPING	SHEET 12	RCP4-RODA-ELS-4B_AE-DR-CH-403112
LANDSCAPING	SHEET 13	RCP4-RODA-ELS-4B_AE-DR-CH-403113

PART VIII PLANNING AUGUST - 2023



AECOM - Roughan & O'Donovan Alliance

ROUGHAN & O'DONOVAN
CONSULTING ENGINEERS
ARENA HOUSE, ARENA ROAD,
SANDYFORD, DUBLIN 18
D18 V8P6, IRELAND

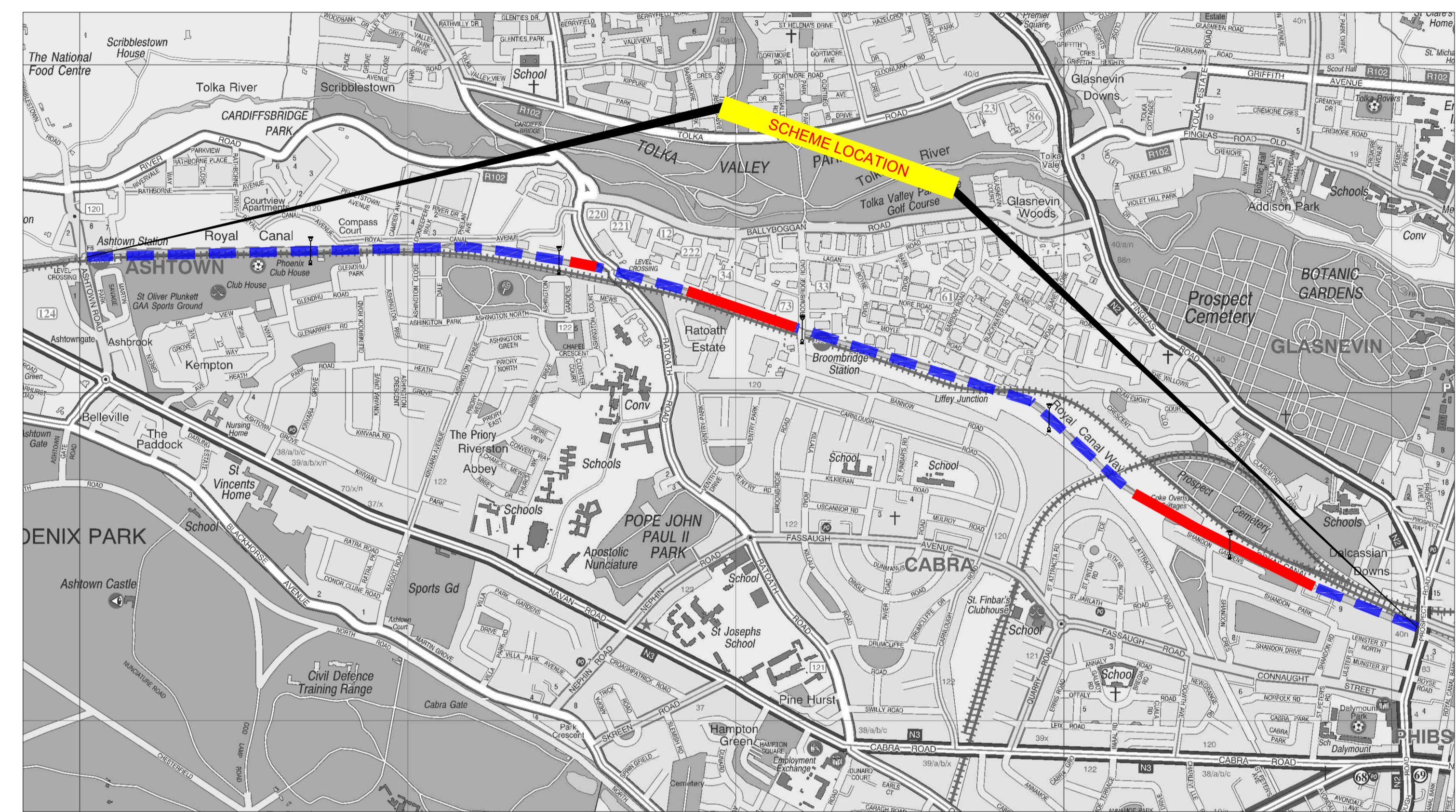
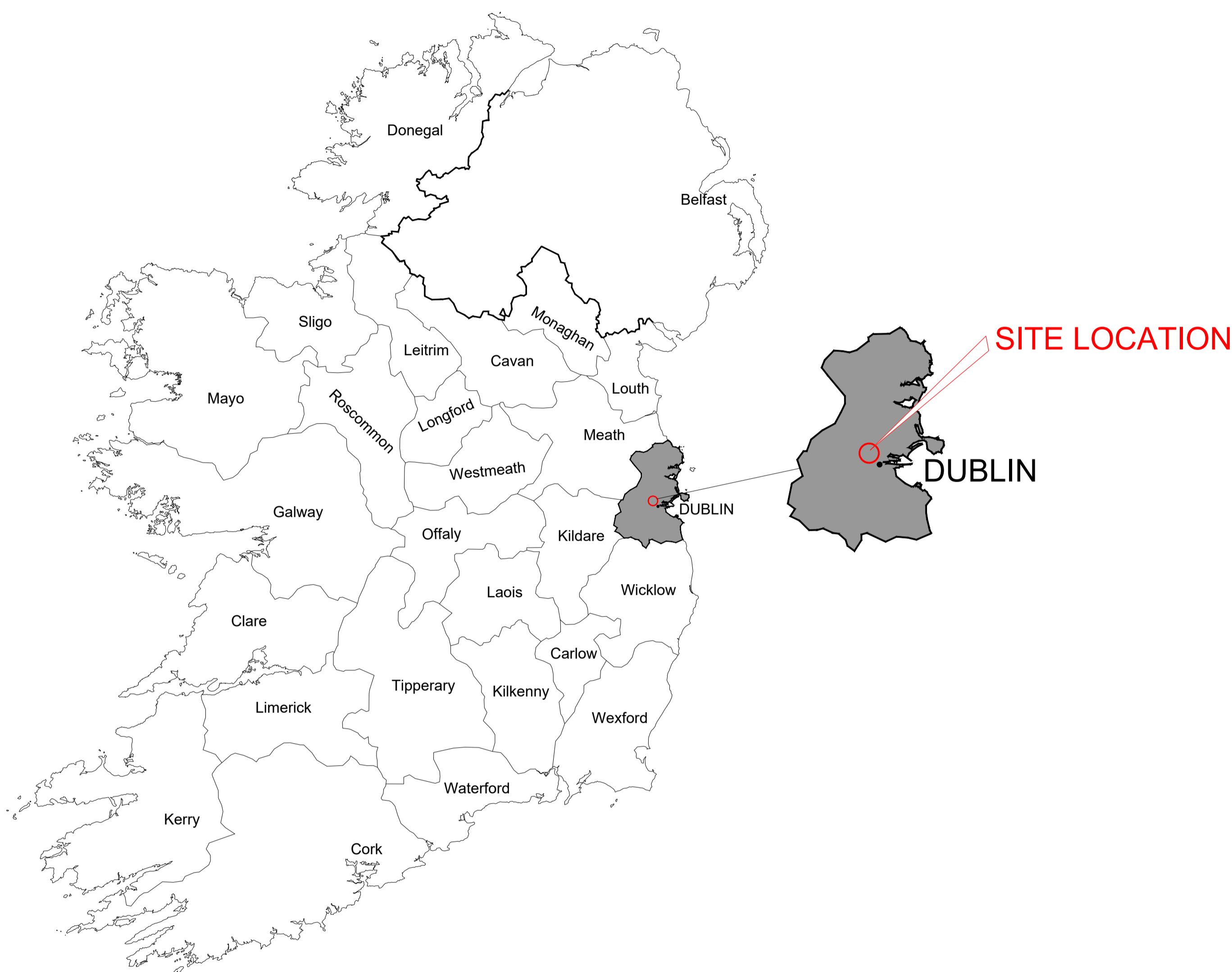
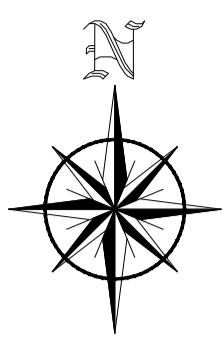

LEGEND:

	ORIGINAL PART 8 EXTENT
	AMENDING PART 8 EXTENT



No.	Revision	Date	By	Chkd	App'd
P02	ISSUE	17.03.2023	GBR	EOC	EOC
P03	ISSUE	30.03.2023	GBR	EOC	EOC

AECOM - Roughan & O'Donovan Alliance



ROUGHAN & O'DONOVAN
CONSULTING ENGINEERS
ARENA HOUSE, ARENA ROAD,
SANDYFORD, DUBLIN 18
D18 V8P6, IRELAND

Project Title: Royal Canal Greenway Cycle And Pedestrian Route Phase 4 Phibsborough to Ashtown - Amending Part VIII

Drawing Title: SITE LOCATION MAP KEY PLAN

Drawing Number	Project	Originator	Volume	Location	Type	Role	Number
RCP4	-	ROD	-	GEN	-	4B_AE	- DR - CH - 400000

Drawn: AG	Designed: DN	Checked: EOC	Approved: SMG	Status: S2 - Planning
-----------	--------------	--------------	---------------	-----------------------

Scale (A1): NTS	Date: AUG 21	Job No: 18.152	Rev: P03
-----------------	--------------	----------------	----------

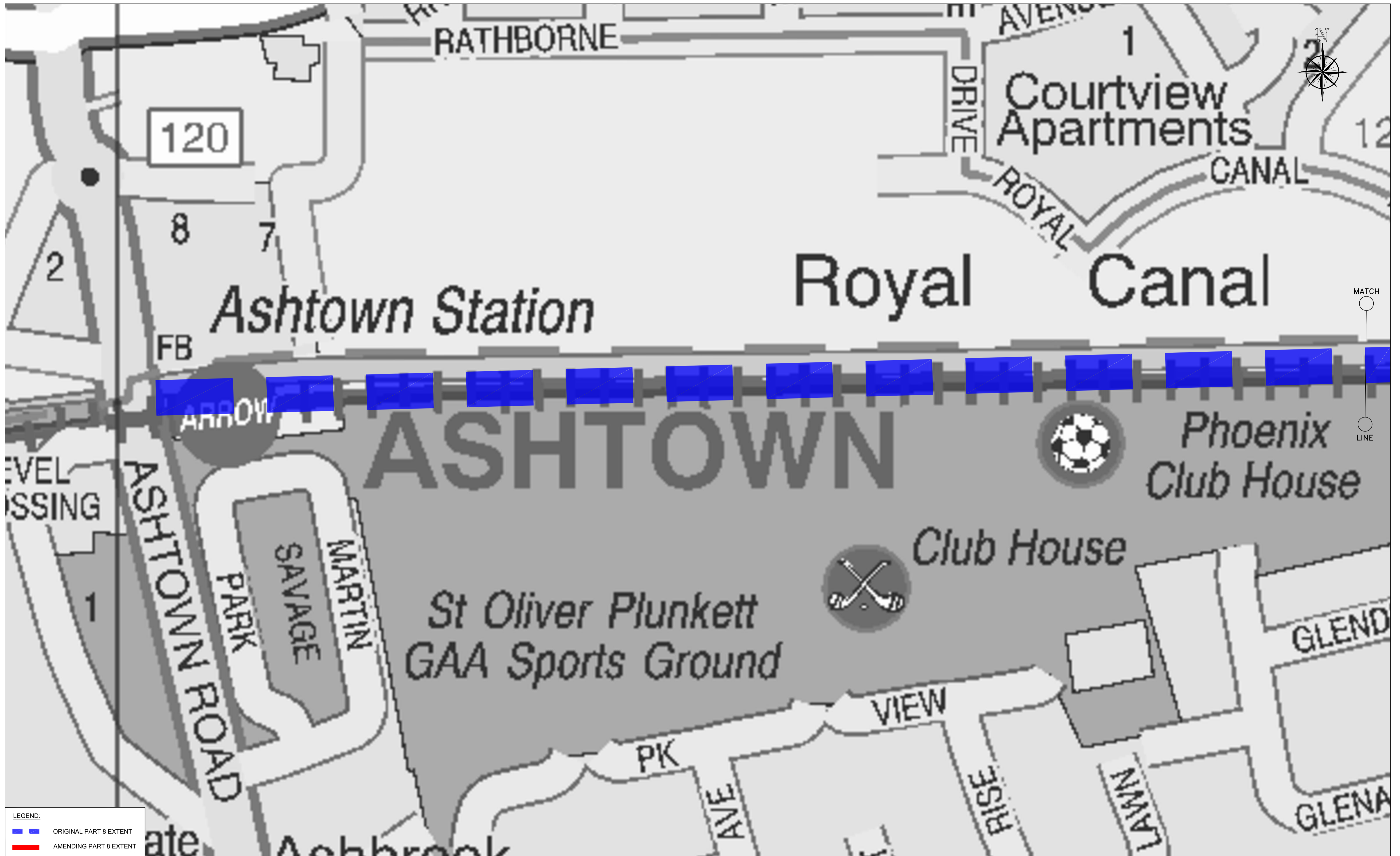

LEGEND:

	ORIGINAL PART 8 EXTENT
	AMENDING PART 8 EXTENT



No.	Revision	Date	By	Chkd	App'd
P01	ISSUE	30.03.2023	GBR	EOC	EOC

AECOM - Roughan & O'Donovan Alliance

ROD
ROUGHAN & O'DONOVAN
CONSULTING ENGINEERS
ARENA HOUSE, ARENA ROAD,
SANDYFORD, DUBLIN 18
D18 V8P6, IRELAND

Drawn: GBR | Designed: GBR | Checked: EOC | Approved: SMG | Status: S2 - Planning

Project Title: Royal Canal Greenway Cycle And Pedestrian Route Phase 4 Phibsborough to Ashtown - Amending Part VIII						
Drawing Title: SITE LOCATION MAP SHEET 1 OF 6						
Drawing Number	Project	Originator	Volume	Location	Type	Role
RCP4	RCP4	ROD	GEN	4B_AE	DR	CH
400001						
Scale (A1)	1:1000	Date:	MAR 23	Job No:	18.152	Rev:
						P01

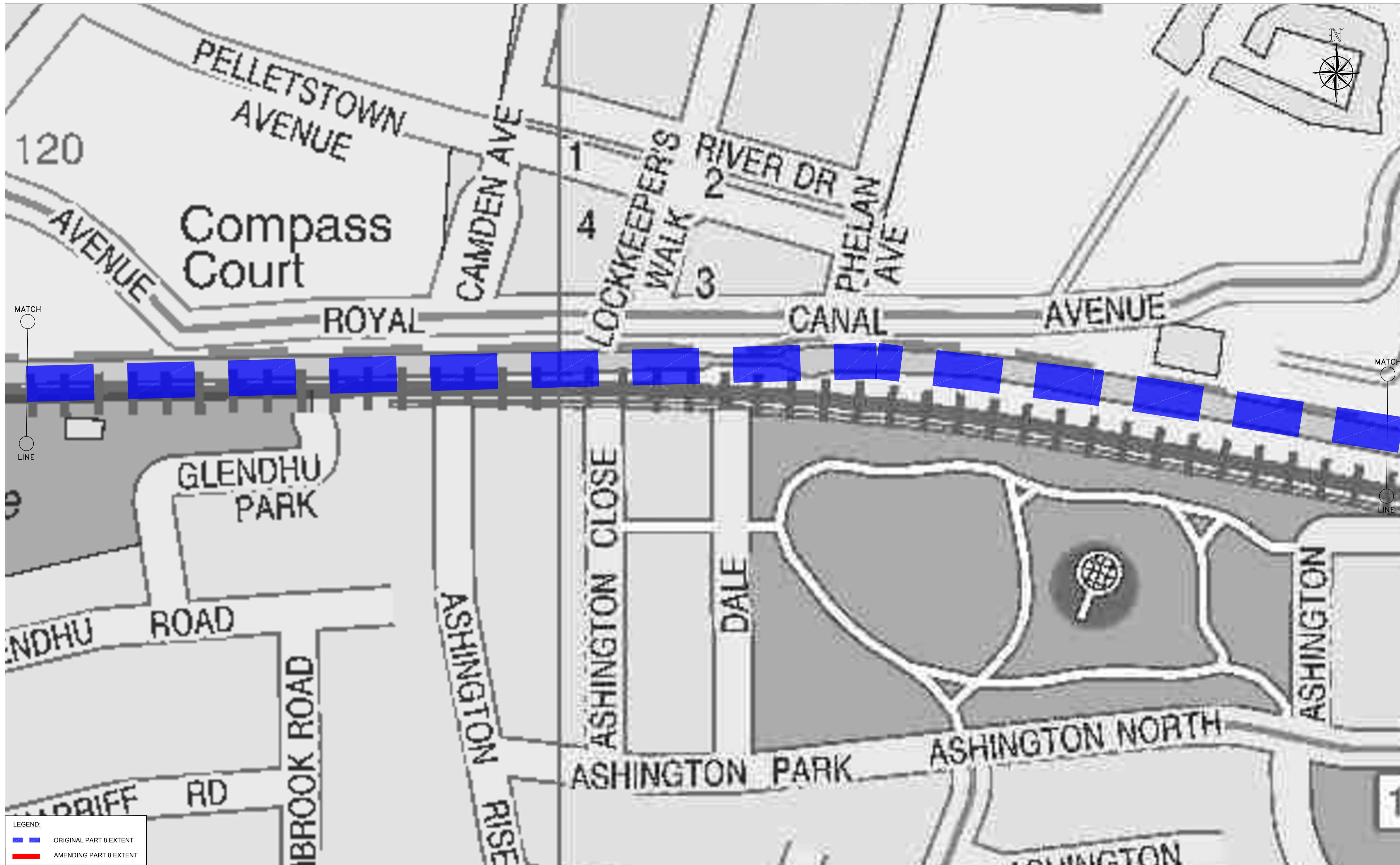

LEGEND:

	ORIGINAL PART 8 EXTENT
	AMENDING PART 8 EXTENT



No.	Revision	Date	By	Chkd	App'd
P01	ISSUE	30.03.2023	GBR	EOC	EOC

AECOM - Roughan & O'Donovan Alliance

ROUGHAN & O'DONOVAN
CONSULTING ENGINEERS
ARENA HOUSE, ARENA ROAD,
SANDYFORD, DUBLIN 18
D18 V8P6, IRELAND

Drawn: GBR | Designed: GBR | Checked: EOC | Approved: SMG | Status: S2 - Planning

Project Title: Royal Canal Greenway Cycle And Pedestrian Route Phase 4 Phibsborough to Ashtown - Amending Part VIII						
Drawing Title: SITE LOCATION MAP SHEET 2 OF 6						
Project	Originator	Volume	Location	Type	Role	Number
RCP4	ROD	GEN	4B_AE	DR	CH	400002
Scale (A1)	1:1000	Date:	MAR 23	Job No:	18.152	Rev: P01

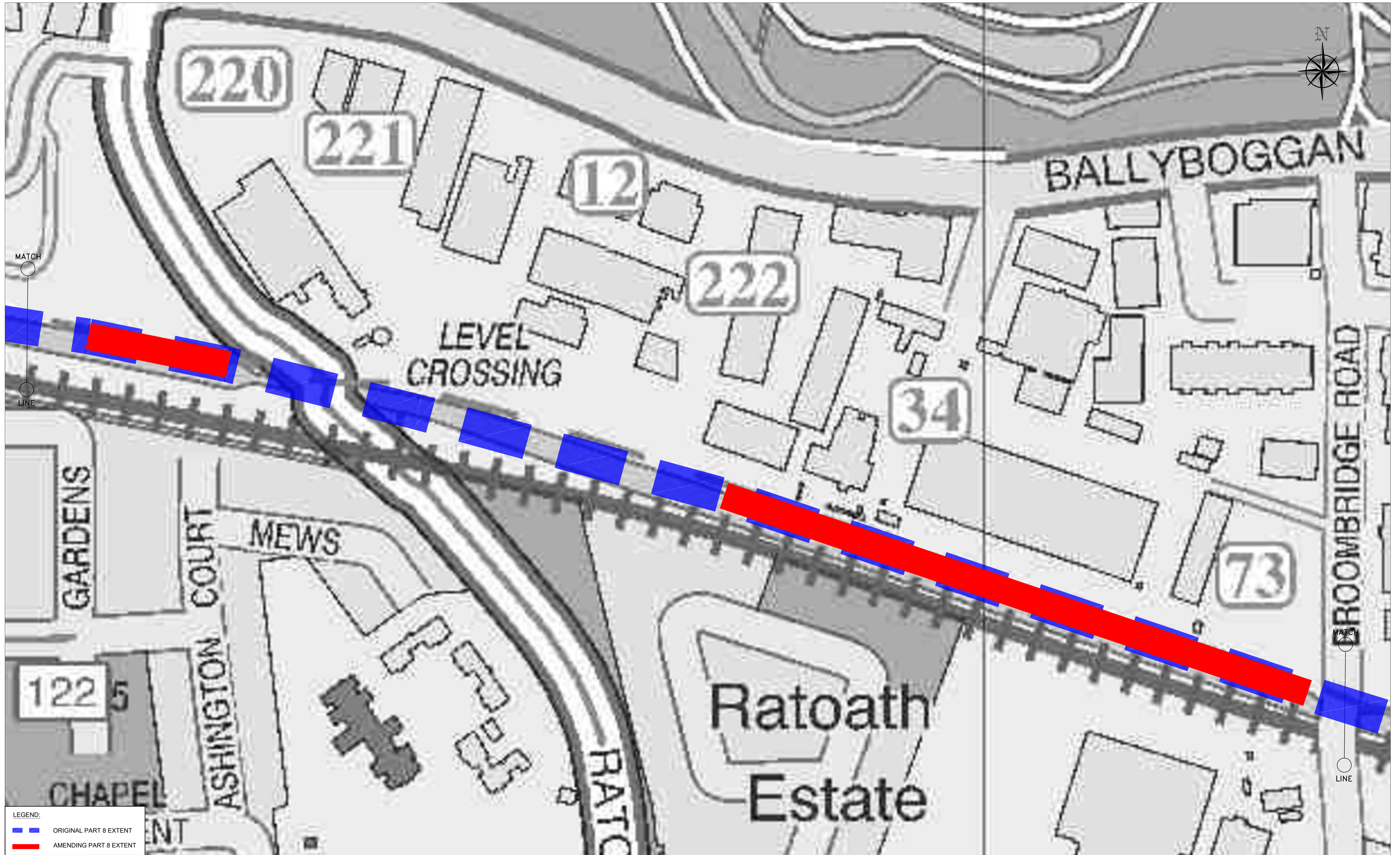

LEGEND:
 ORIGINAL PART 8 EXTENT
 AMENDING PART 8 EXTENT

Tionscaldal Éireann
Project Ireland
2040

Comhairle Cathrach
Bhaile Átha Cliath
Dublin City Council

NTA
Údarás Náisiúnta Iompair
National Transport Authority

No.	Revision	Date	By	Chkd	App'd
P01	ISSUE	30.03.2023	GBR	EOC	EOC

AECOM - Roughan & O'Donovan Alliance

ROD
ROUGHAN & O'DONOVAN
CONSULTING ENGINEERS
ARENA HOUSE, ARENA ROAD,
SANDYFORD, DUBLIN 18
D18 V8P6, IRELAND

Drawn: GBR | Designed: GBR | Checked: EOC | Approved: SMG | Status: S2 - Planning

Project Title: Royal Canal Greenway Cycle And Pedestrian Route Phase 4 Phibsborough to Ashtown - Amending Part VIII						
Drawing Title: SITE LOCATION MAP SHEET 3 OF 6						
Project	Originator	Volume	Location	Type	Role	Number
RCP4	ROD	GEN	4B_AE	DR	CH	400003
Scale (A1)	1:1000	Date:	MAR 23	Job No:	18.152	Rev: P01

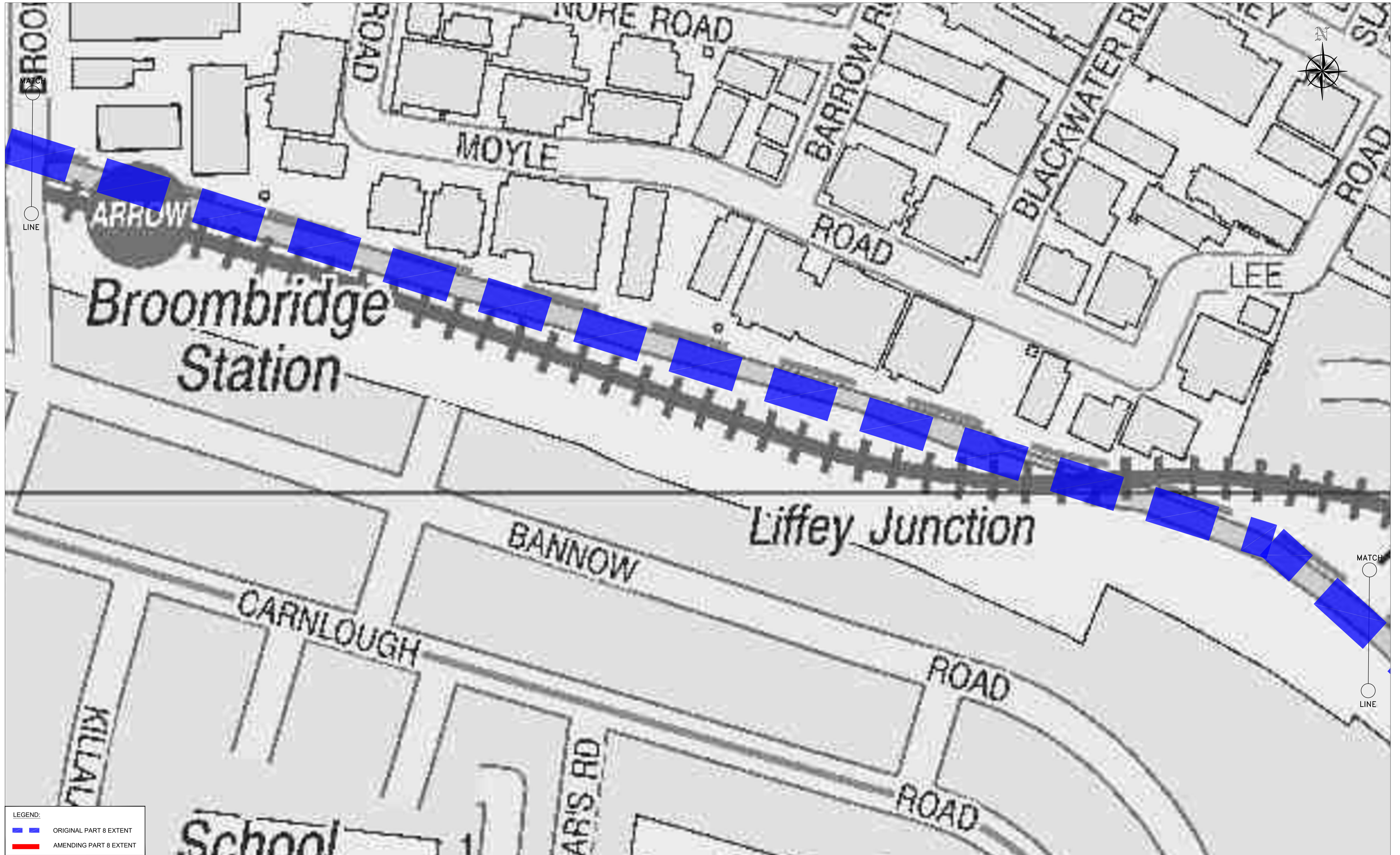

LEGEND:
 ORIGINAL PART 8 EXTENT
 AMENDING PART 8 EXTENT



Comhairle Cathrach
Bhaile Átha Cliath
Dublin City Council



No.	Revision	Date	By	Chkd	App'd
P01	ISSUE	30.03.2023	GBR	EOC	EOC

AECOM - Roughan & O'Donovan Alliance

ROUGHAN & O'DONOVAN
CONSULTING ENGINEERS
ARENA HOUSE, ARENA ROAD,
SANDYFORD, DUBLIN 18
D18 V8P6, IRELAND

Drawn: GBR | Designed: GBR | Checked: EOC | Approved: SMG | Status: S2 - Planning

Project Title: Royal Canal Greenway Cycle And Pedestrian Route Phase 4 Phibsborough to Ashtown - Amending Part VIII						
Drawing Title: SITE LOCATION MAP SHEET 4 OF 6						
Project	Originator	Volume	Location	Type	Role	Number
RCP4	ROD	GEN	4B_AE	DR	CH	400004
Scale (A1)	1:1000	Date:	MAR 23	Job No:	18.152	Rev: P01

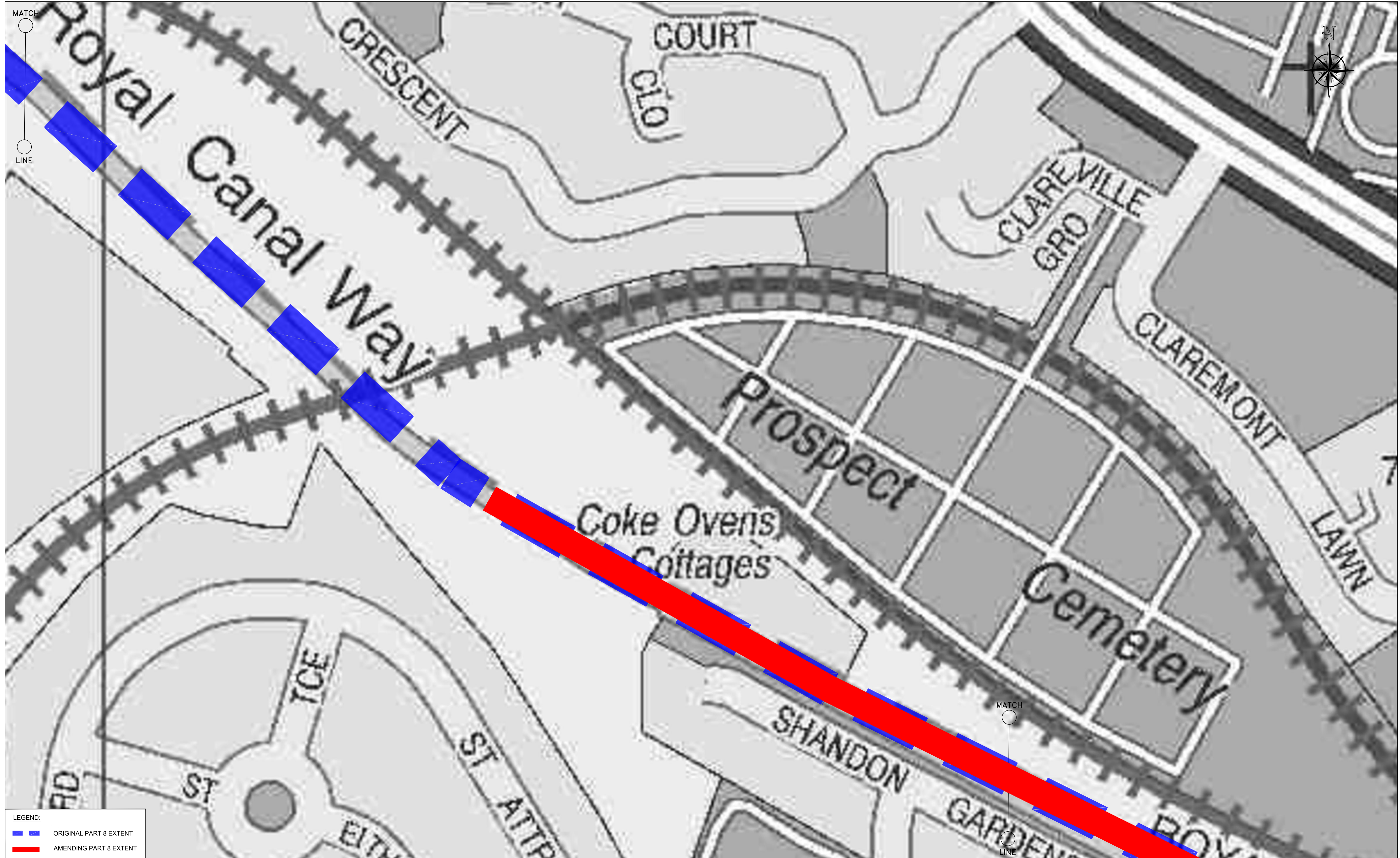

LEGEND:

	ORIGINAL PART 8 EXTENT
	AMENDING PART 8 EXTENT

Tionscadal Éireann
Project Ireland
2040

Comhairle Cathrach
Bhaile Átha Cliath
Dublin City Council

NTA
Údarás Náisiúnta Iompair
National Transport Authority

No.	Revision	Date	By	Chkd	App'd
P01	ISSUE	30.03.2023	GBR	EOC	EOC

AECOM - Roughan & O'Donovan Alliance

ROUGHAN & O'DONOVAN
CONSULTING ENGINEERS
ARENA HOUSE, ARENA ROAD,
SANDYFORD, DUBLIN 18
D18 V8P6, IRELAND

Drawn: GBR | Designed: GBR | Checked: EOC | Approved: SMG | Status: S2 - Planning

Project Title		Royal Canal Greenway Cycle And Pedestrian Route Phase 4 Phibsborough to Ashtown - Amending Part VIII			
Drawing Title		SITE LOCATION MAP SHEET 5 OF 6			
Project	Originator	Volume	Location	Type	Role
RCP4	ROD	GEN	4B_AE	DR	CH
Number	400005				
Scale (A1)	1:1000	Date	MAR 23	Job No	18.152
Rev	P01				

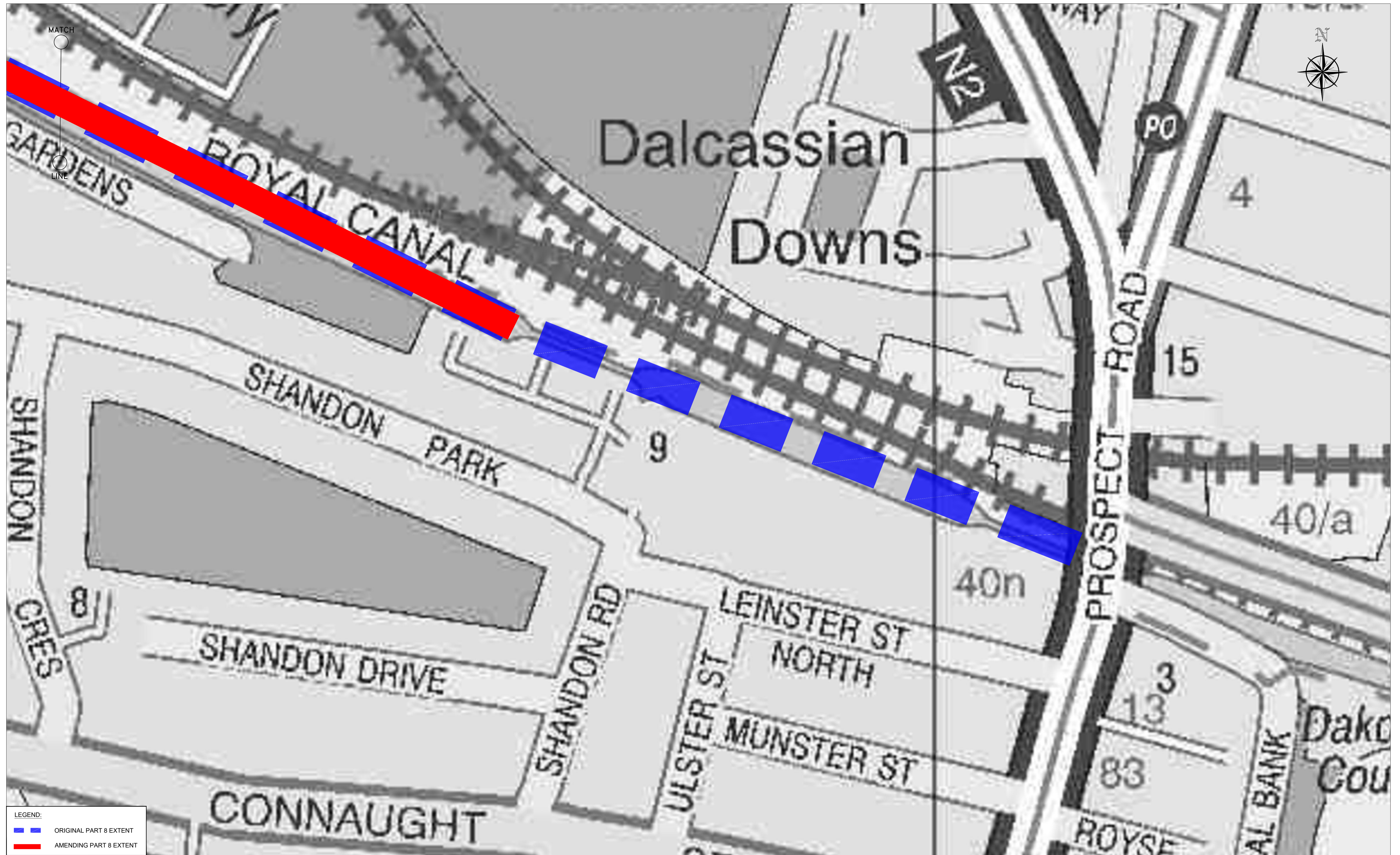

LEGEND:
 ORIGINAL PART 8 EXTENT
 AMENDING PART 8 EXTENT



No.	Revision	Date	By	Chkd	App'd
P01	ISSUE	30.03.2023	GBR	EOC	EOC

AECOM - Roughan & O'Donovan Alliance

ROUGHAN & O'DONOVAN CONSULTING ENGINEERS
 ARENA HOUSE, ARENA ROAD,
 SANDYFORD, DUBLIN 18
 D18 V8P6, IRELAND

Drawn: GBR | Designed: GBR | Checked: EOC | Approved: SMG | Status: S2 - Planning

Project Title		Royal Canal Greenway Cycle And Pedestrian Route Phase 4 Phibsborough to Ashtown - Amending Part VIII					
Drawing Title		SITE LOCATION MAP SHEET 6 OF 6					
Project	Originator	Volume	Location	Type	Role	Number	
RCP4	ROD	GEN	4B_AE	DR	CH	400006	
Scale (A1)	1:1000	Date	MAR 23	Job No:	18.152	Rev: P01	

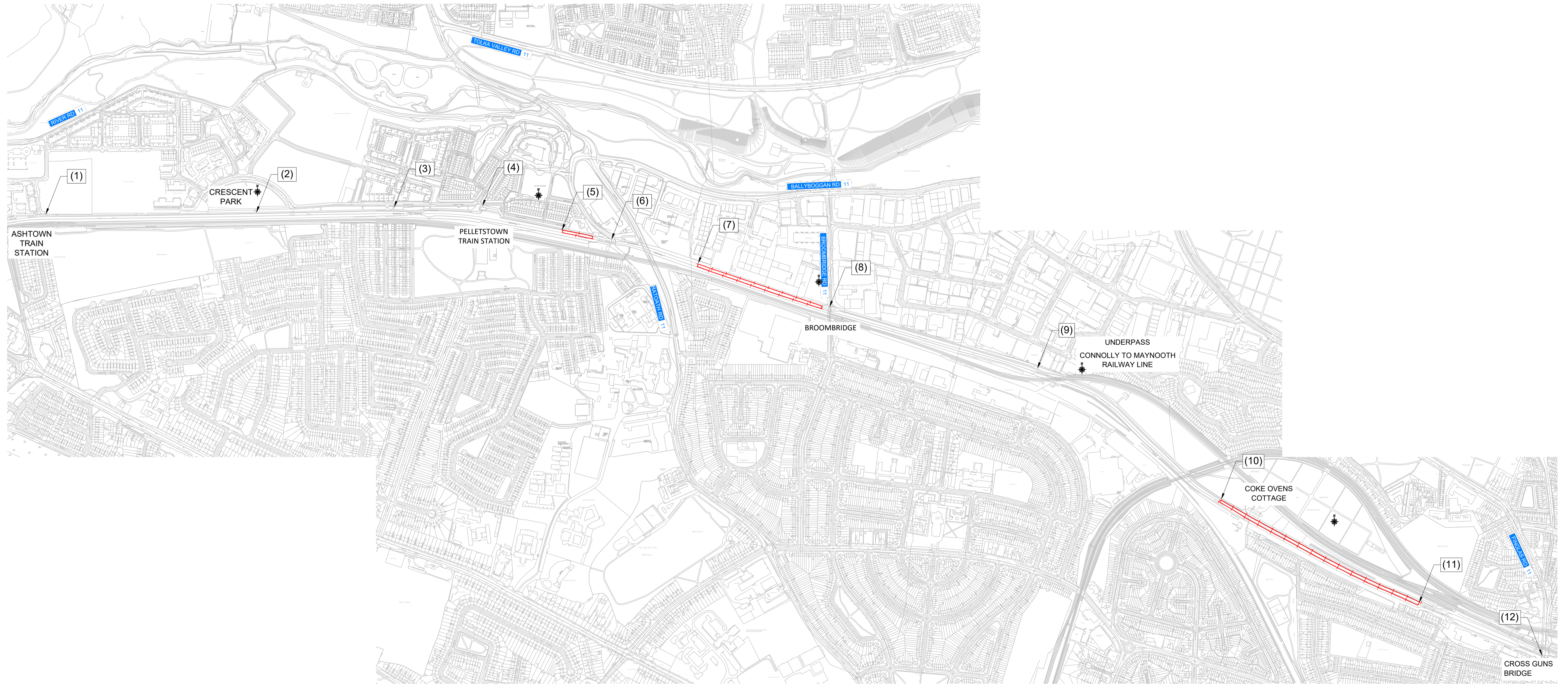

LEGEND:

(1)	SITE NOTICE LOCATIONS
[Red outline]	AMENDING PART 8 EXTENT



No.	Revision	Date	By	Chkd	App'd
P02	ISSUE	17.03.2023	GBR	EOC	EOC
P03	ISSUE	30.03.2023	GBR	EOC	EOC

AECOM - Roughan & O'Donovan Alliance



ROUGHAN & O'DONOVAN CONSULTING ENGINEERS
ARENA HOUSE, ARENA ROAD,
SANDYFORD, DUBLIN 18
D18 V8P6, IRELAND

Project Title: Royal Canal Greenway Cycle And Pedestrian Route Phase 4 Phibsborough to Ashtown - Amending Part VIII

Drawing Title: SITE NOTICE LOCATION KEY PLAN

Drawing Number	Project	Originator	Volume	Location	Type	Role	Number
RCP4	-	ROD	-	GEN	-	4B_AE	- DR - CH - 400200

Drawn: AG	Designed: DN	Checked: EOC	Approved: SMG	Status: S2 - Planning	Scale (A1): NTS	Date: AUG 21	Job No: 18.152	Rev: P02
-----------	--------------	--------------	---------------	-----------------------	-----------------	--------------	----------------	----------

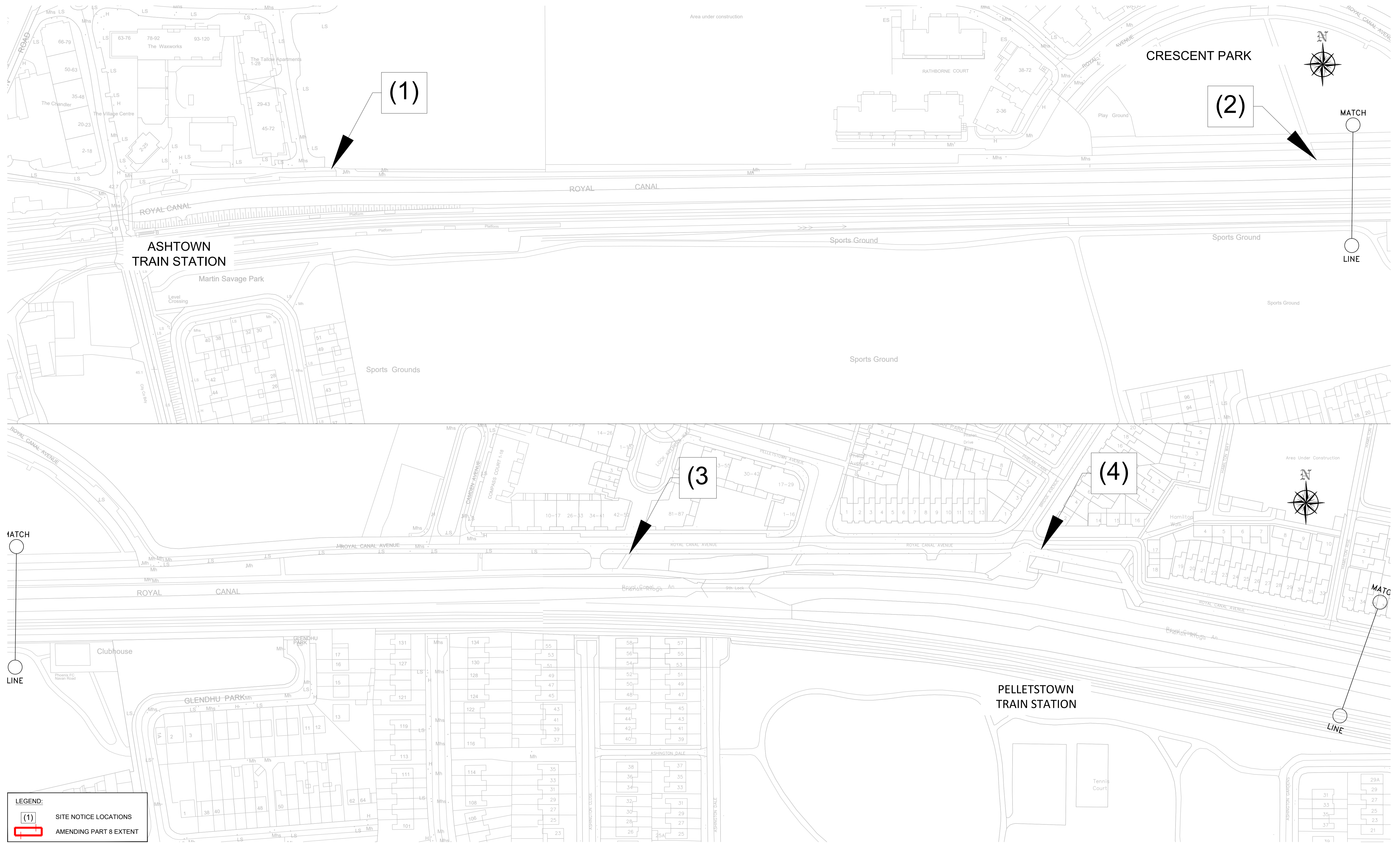

LEGEND:

(1) SITE NOTICE LOCATIONS

AMENDING PART 8 EXTENT



No.	Revision	Date	By	Chkd	App'd
P01	ISSUE	30.03.2023	GBR	EOC	EOC

AECOM - Roughan & O'Donovan Alliance



ROUGHAN & O'DONOVAN CONSULTING ENGINEERS
 ARENA HOUSE, ARENA ROAD,
 SANDYFORD, DUBLIN 18
 D18 V8P6, IRELAND

Project Title: Royal Canal Greenway Cycle And Pedestrian Route Phase 4 Phibsborough to Ashtown - Amending Part VIII

Drawing Title: SITE NOTICE LOCATION SHEET 1 OF 3

Drawing Number	Project	Originator	Volume	Location	Type	Role	Number					
RCP4	-	ROD	-	GEN	-	4B_AE	-	DR	-	CH	-	400201

Scale (A1)	Date	Job No.	Rev.
1:1000	MAR 23	18.152	P01

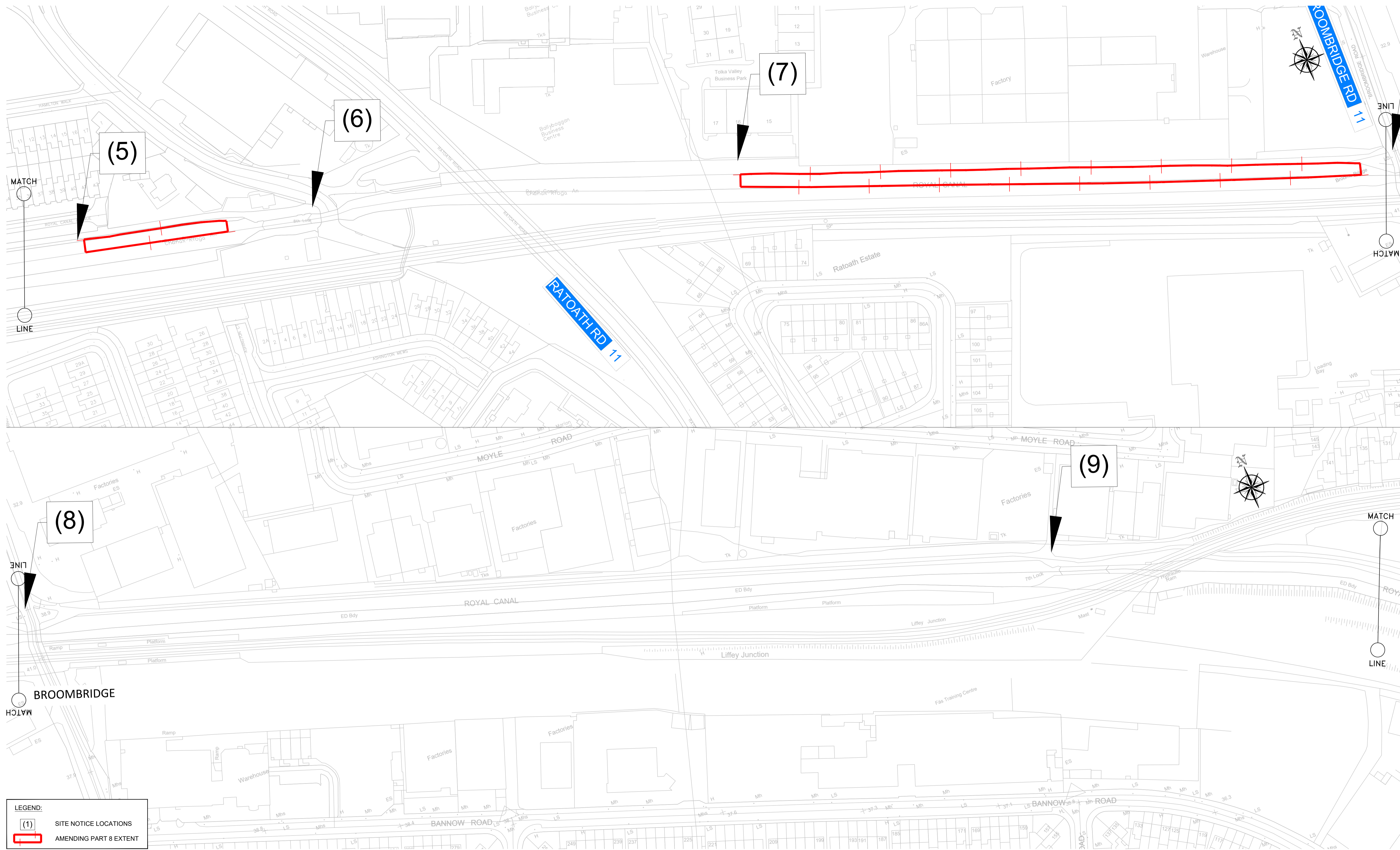

LEGEND:
(1) SITE NOTICE LOCATIONS
 AMENDING PART 8 EXTENT



No.	Revision	Date	By	Chkd	App'd
P01	ISSUE	30.03.2023	GBR	EOC	EOC

AECOM - Roughan & O'Donovan Alliance



ROUGHAN & O'DONOVAN
 CONSULTING ENGINEERS
 ARENA HOUSE, ARENA ROAD,
 SANDYFORD, DUBLIN 18
 D18 V8P6, IRELAND

Project Title: Royal Canal Greenway Cycle And Pedestrian Route Phase 4 Phibsborough to Ashtown - Amending Part VIII

Drawing Title: SITE NOTICE LOCATION SHEET 2 OF 3

Drawing Number	Project	Originator	Volume	Location	Type	Role	Number
RCP4	-	ROD	-	GEN	-	4B_AE	-

Scale (A1)	Date	Job No.	Rev.
1:1000	MAR 23	18.152	P01

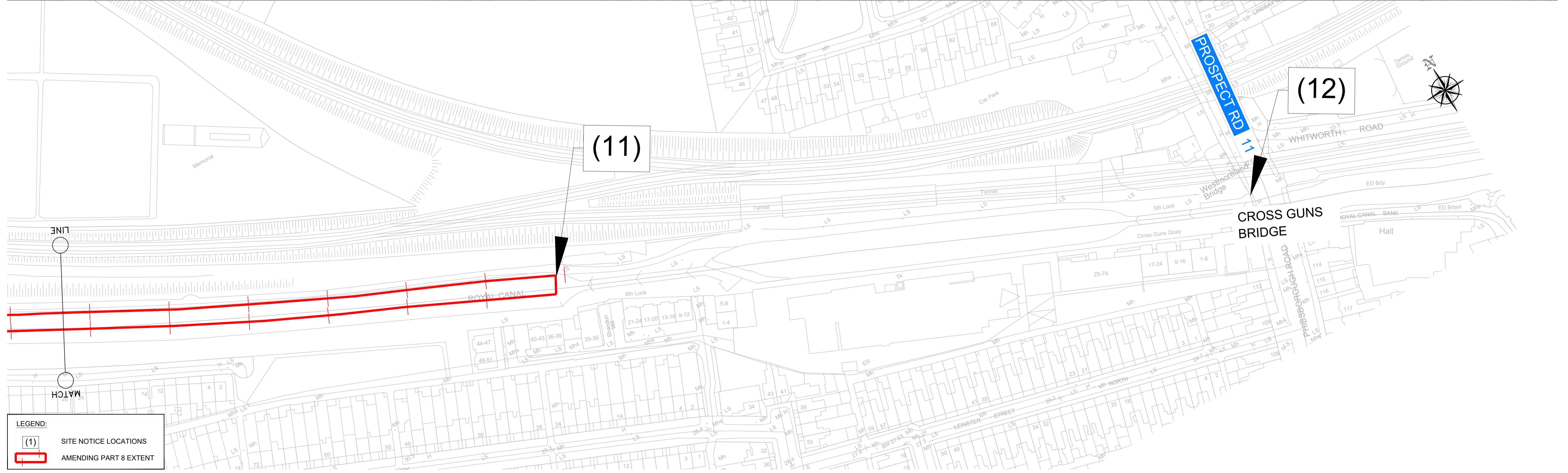
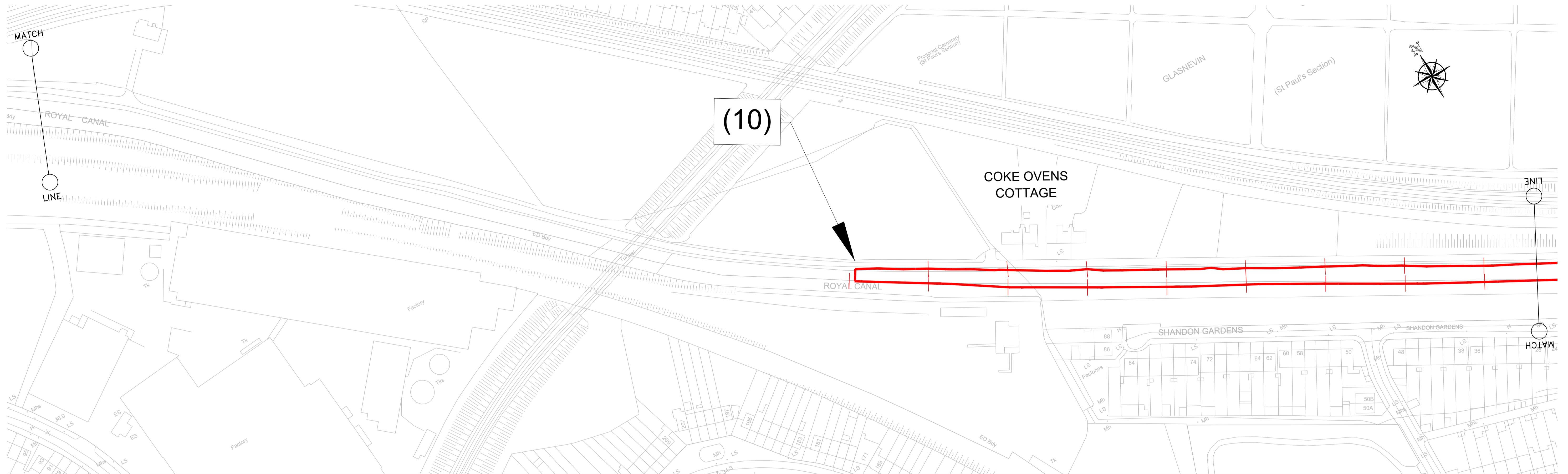

LEGEND:

(1) SITE NOTICE LOCATIONS

[Red Line] AMENDING PART 8 EXTENT



No.	Revision	Date	By	Chkd	App'd
P01	ISSUE	30.03.2023	GBR	EOC	EOC

AECOM - Roughan & O'Donovan Alliance

ROD
ROUGHAN & O'DONOVAN

AECOM

ROUGHAN & O'DONOVAN CONSULTING ENGINEERS
ARENA HOUSE, ARENA ROAD,
SANDYFORD, DUBLIN 18
D18 V8P6, IRELAND

Drawn: AG | Designed: DN | Checked: EOC | Approved: SMG | Status: S2 - Planning

Project Title: Royal Canal Greenway Cycle And Pedestrian Route Phase 4 Phibsborough to Ashtown - Amending Part VIII						
Drawing Title: SITE NOTICE LOCATION SHEET 3 OF 3						
Project Number	Originator	Volume	Location	Type	Role	Number
RCP4	ROD	GEN	4B_AE	DR	CH	400203
Scale (A1)	1:1000	Date:	MAR 23	Job No:	18.152	Rev: P01

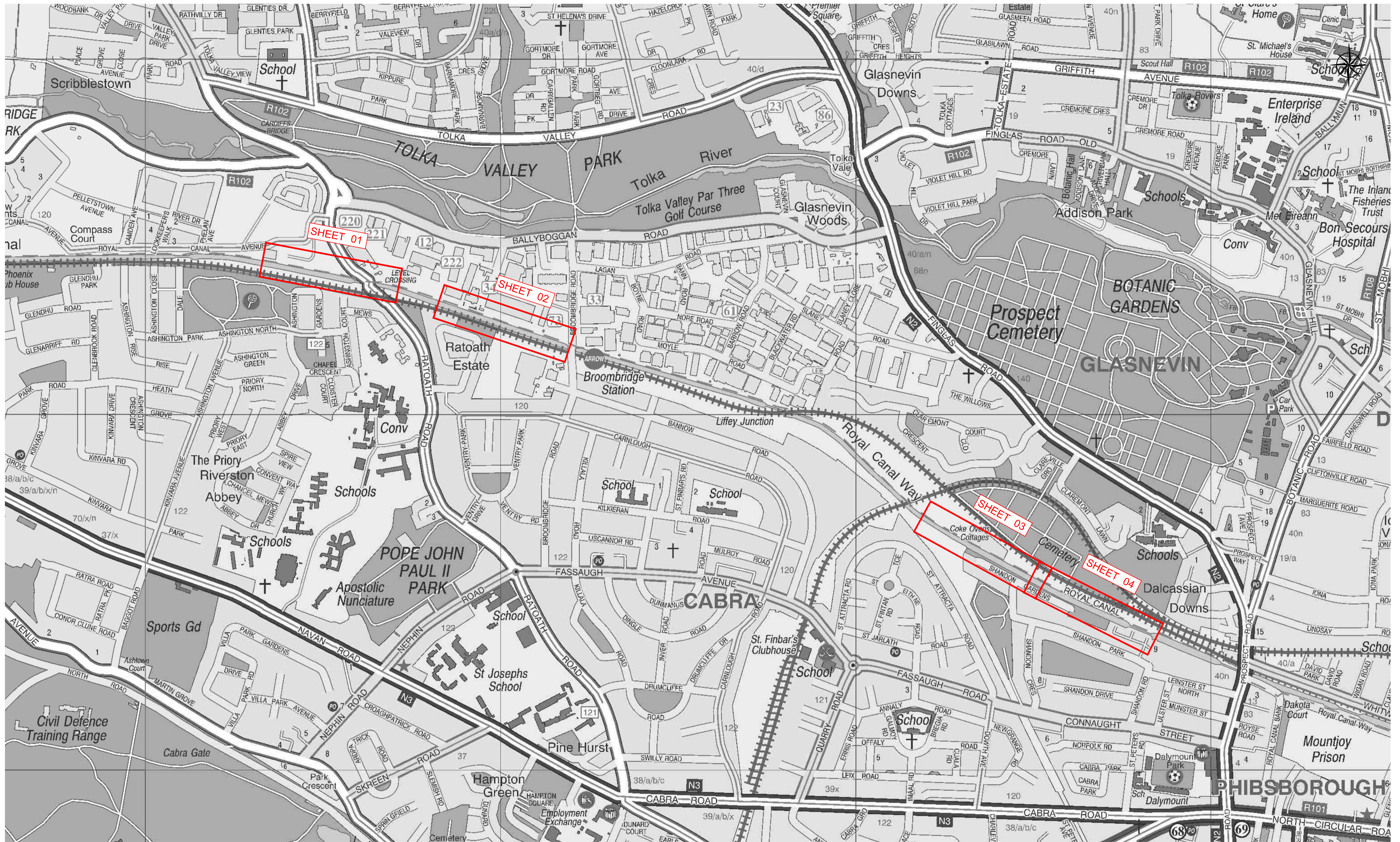

No.	Revision	Date	By	Chkd	App'd
P02	ISSUE	17.03.2023	GBR	EOC	EOC

AECOM - Roughan & O'Donovan Alliance



ROUGHAN & O'DONOVAN CONSULTING ENGINEERS
ARENA HOUSE, ARENA ROAD,
SANDYFORD, DUBLIN 18
D18 V8P6, IRELAND

Project Title: Royal Canal Greenway Cycle And Pedestrian Route Phase 4 Phibsborough to Ashtown - Amending Part VIII

Drawing Title: KEY PLAN

Project Number	Originator	Volume	Location	Type	Role	Number
RCP4	ROD	GEN	4B_AE	DR	CH	400100

Drawn: AG | Designed: DN | Checked: EOC | Approved: SMG | Status: S2 - Planning

Scale (A1): 1:5,000 | Date: AUG 21 | Job No: 18.152 | Rev: P02

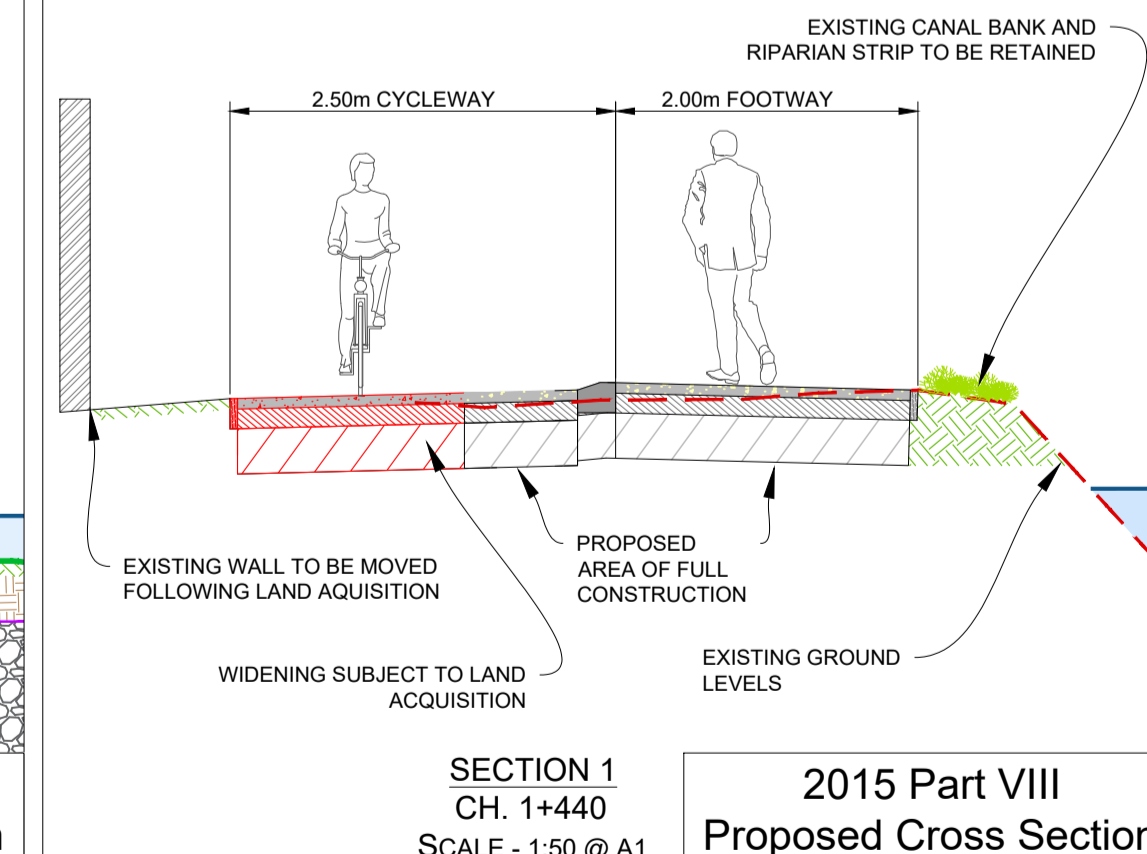
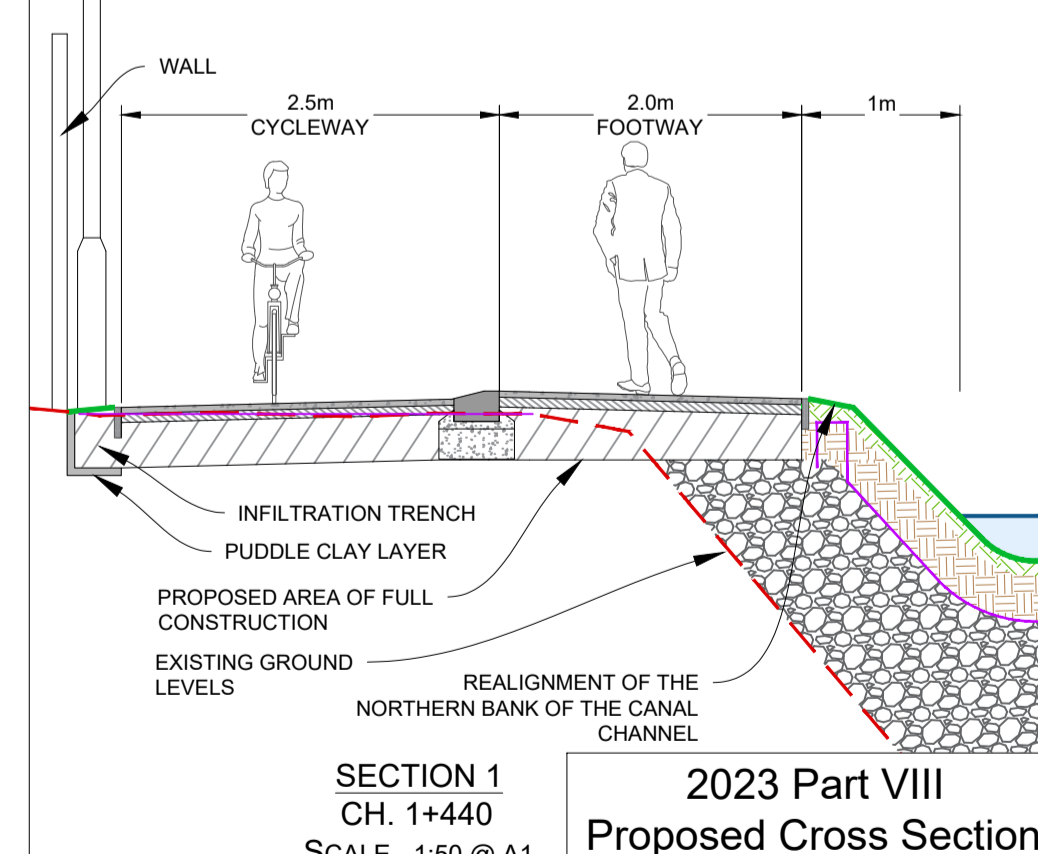
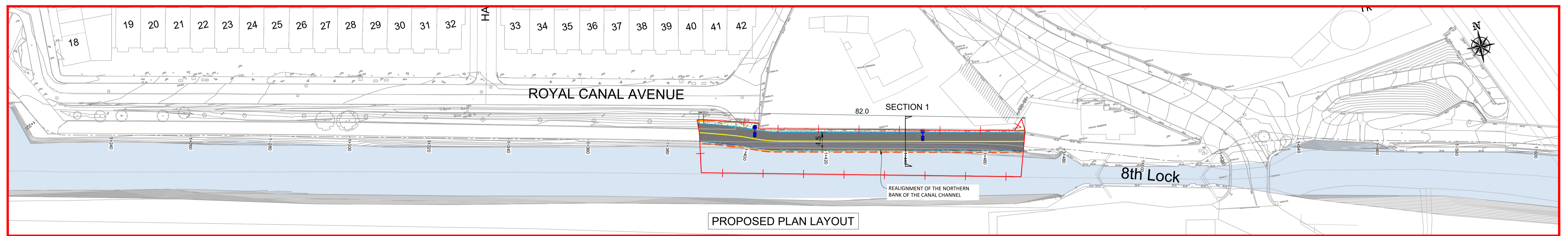
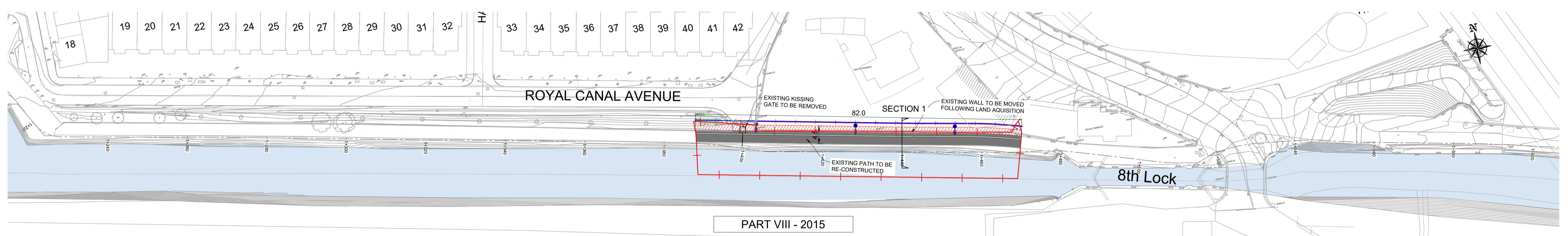
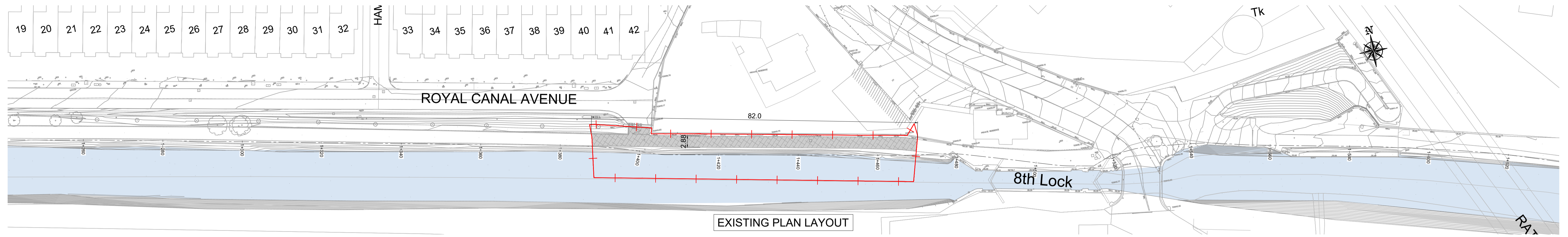

PLAN VIEWS LEGEND:

- EXISTING FOOTPATHS
- PROPOSED GREENWAY SURFACE
- PROPOSED SHARED SURFACE
- PROPOSED BUFF SURFACE
- ROYAL CANAL NAVIGATION CHANNEL
- PROPOSED CCTV POLE
- PROPOSED PUBLIC LIGHTING
- AREA PROVIDED BY THE EMPLOYER
- PROPOSED WOODEN KERB
- PROPOSED FINISHED CANAL PROFILE
- PROPOSED 45° SPLAY KERB
- PROPOSED LANDSCAPING
- PROPOSED NEW CANAL EMBANKMENT VERGE
- PROPOSED FENCE TYPE A
- PROPOSED PALADIN FENCE
- PROPOSED STEEL PALISADE SECURITY FENCE
- TREES TO BE RETAINED
- PROPOSED BOLLARD
- PROPOSED HDPE LINER
- PUDDLE CLAY LAYER
- PROPOSED SIGN
- NEW CANAL EDGE
- EXISTING CANAL EDGE
- EXISTING CALP WALL TO BE RETAINED
- LAND ACQUISITION LINE PROPOSED UNDER 2015 PART VIII
- PROPOSED WIDENING UNDER 2015 PART VIII
- TOPSOIL LAYER

SECTIONS LEGEND:

- PROPOSED EMBANKMENT PROFILE
- PROPOSED HDPE LINER
- PROPOSED FINISHED CANAL PROFILE

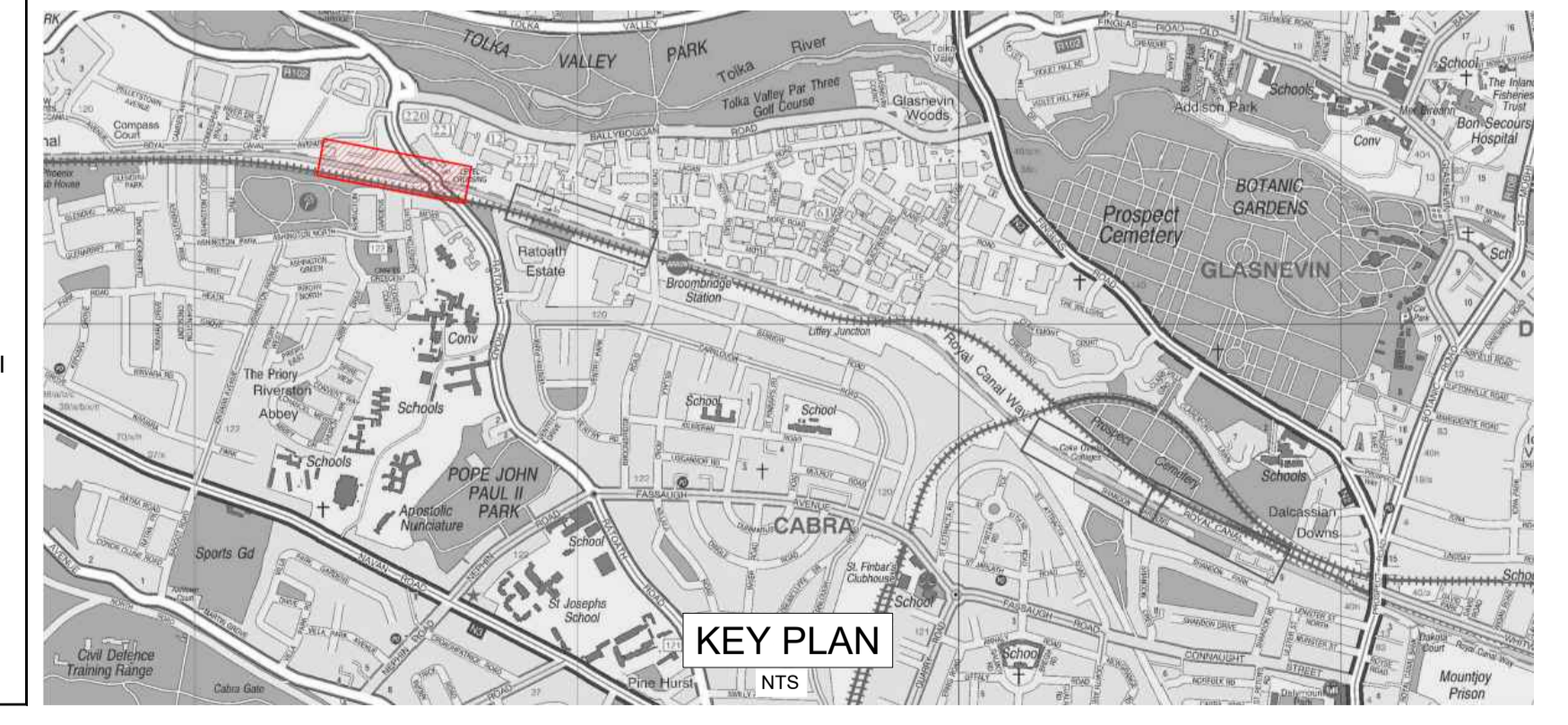

Tionscaldal Éireann
Project Ireland
2040

Comhairle Cathrach
Bhaile Átha Cliath
Dublin City Council

NTA
Údarás Náisiúnta Iompair
National Transport Authority

AECOM - Roughan & O'Donovan Alliance

ROD
ROUGHAN & O'DONOVAN
AECOM

ROUGHAN & O'DONOVAN
CONSULTING ENGINEERS
ARENA HOUSE, ARENA ROAD,
SANDYFORD, DUBLIN 18
D18 V8P6, IRELAND

Project Title		Royal Canal Greenway Cycle And Pedestrian Route Phase 4 Phibsborough to Ashtown - Amending Part VIII					
Drawing Title		SITE LAYOUT PLAN SHEET 01 OF 04					
Project	Originator	Volume	Location	Type	Role	Number	
RCP4	ROD	HGN	4B_AE	DR	CH	400001	
Scale (A1)	1:500	Date	FEB 22	Job No.	18.152	Rev.	
						P07	

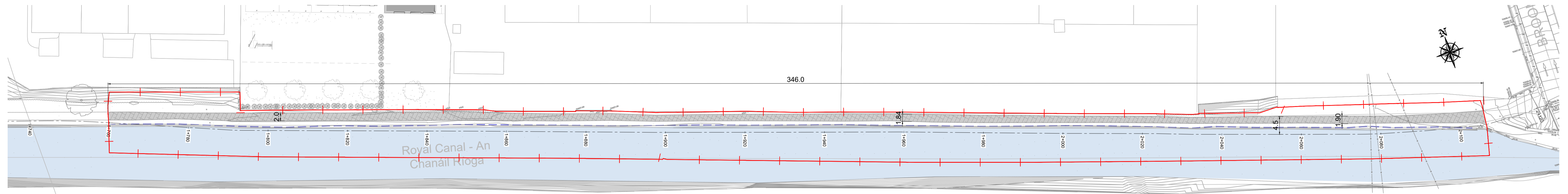

EXISTING PLAN LAYOUT

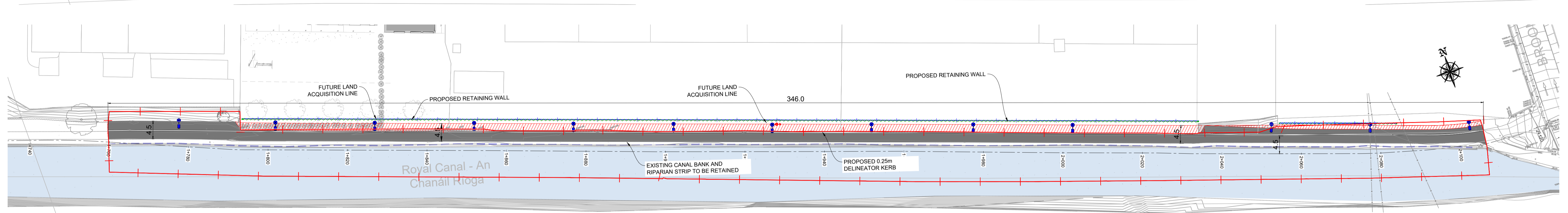

PART VIII - 2015

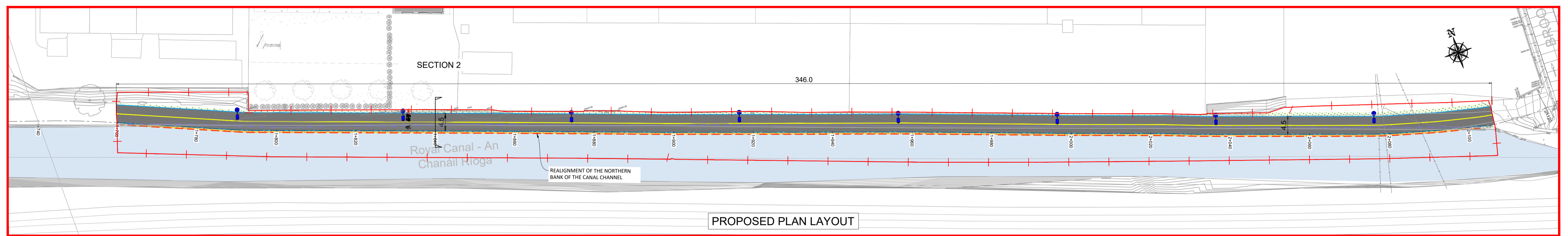

PROPOSED PLAN LAYOUT

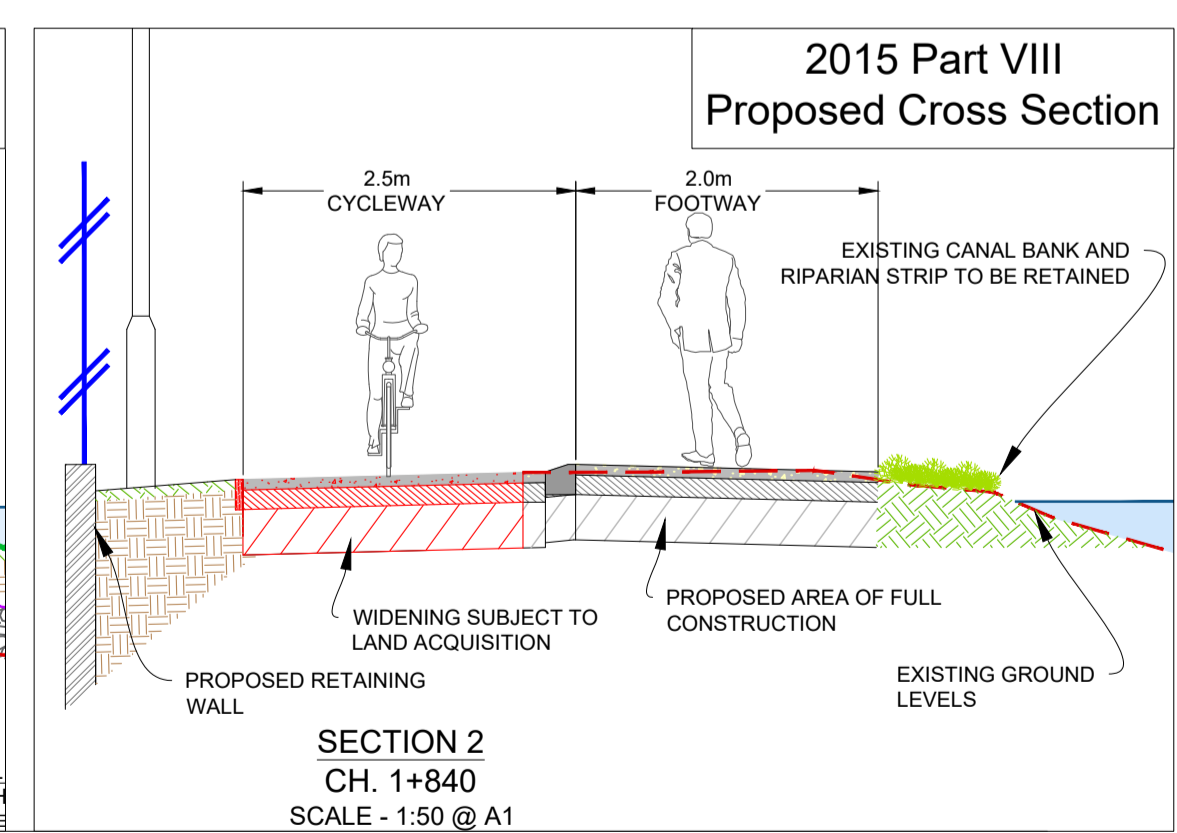
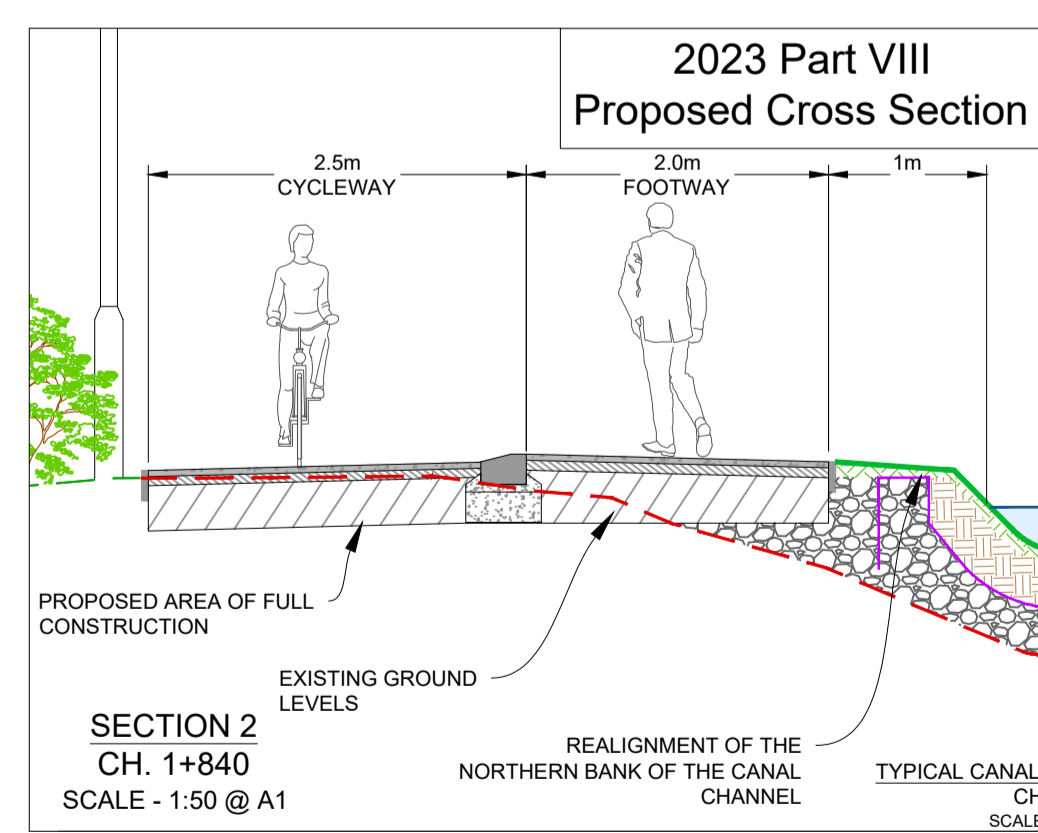

PLAN VIEWS LEGEND:

	EXISTING FOOTPATHS		PROPOSED 45° SPYAL KERB		PROPOSED SIGN
	PROPOSED GREENWAY SURFACE		PROPOSED LANDSCAPING		NEW CANAL EDGE
	PROPOSED SHARED SURFACE		PROPOSED NEW CANAL EMBANKMENT VERGE		EXISTING CANAL EDGE
	PROPOSED BUFF SURFACE		PROPOSED FENCE TYPE A		EXISTING CALP WALL TO BE RETAINED
	ROYAL CANAL NAVIGATION CHANNEL		PROPOSED PALADIN FENCE		LAND ACQUISITION LINE PROPOSED UNDER 2015 PART VIII
	PROPOSED CCTV POLE		PROPOSED STEEL PALISADE SECURITY FENCE		PROPOSED WIDENING UNDER 2015 PART VIII
	PROPOSED PUBLIC LIGHTING		TREES TO BE RETAINED		TOPSOIL LAYER
	AREA PROVIDED BY THE EMPLOYER		PROPOSED HDPE LINER		
	PROPOSED WOODEN KERB		PUDDLE CLAY LAYER		
	PROPOSED FINISHED CANAL PROFILE				

SECTIONS LEGEND:

	PROPOSED EMBANKMENT PROFILE
	PROPOSED FINISHED CANAL PROFILE

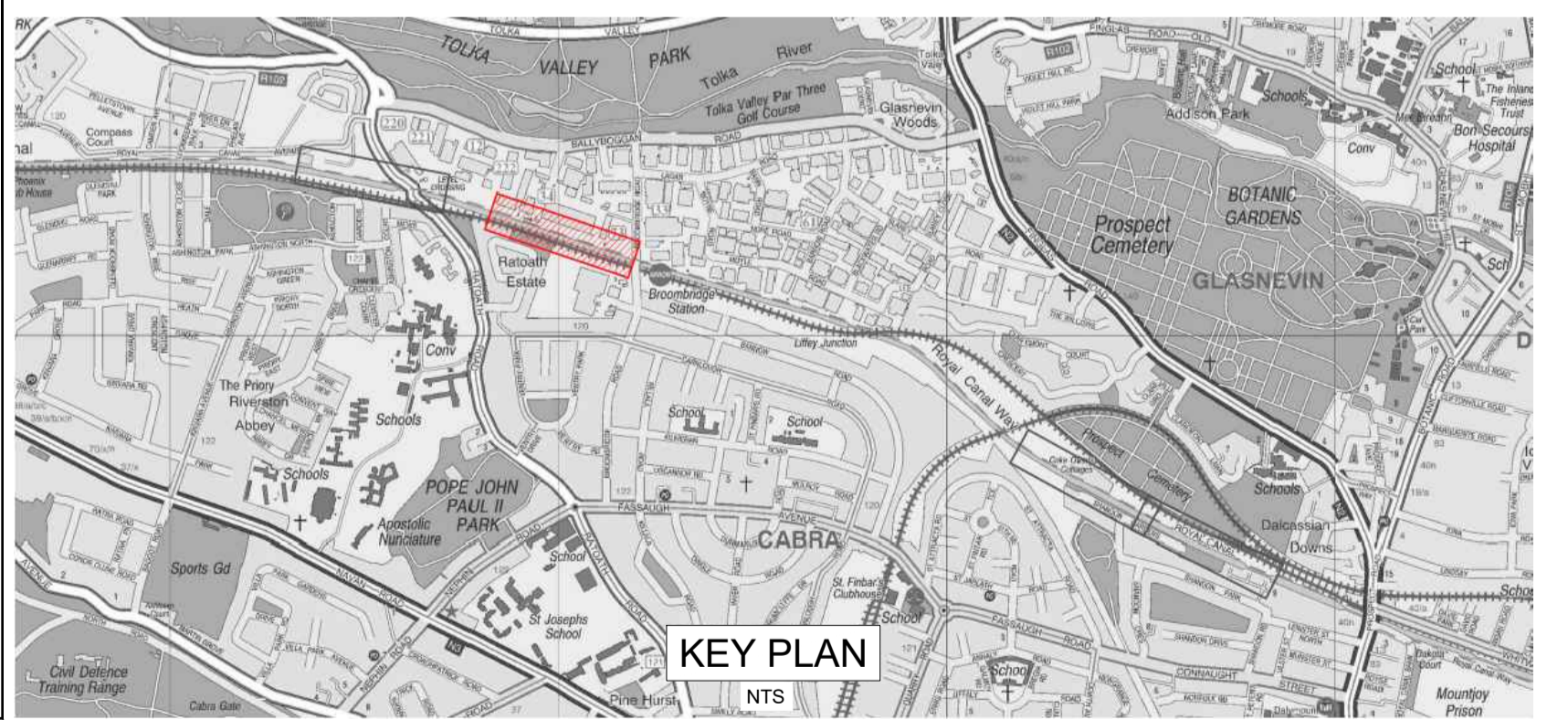

No.	Revision	Date	By	Chkd	App'd
P02	ISSUE	17.03.2023	GBR	EOC	EOC
P03	ISSUE	30.03.23	EOC	EOC	EOC
P04	ISSUE	19.05.2023	GBR	EOC	EOC
P05	ISSUE	09.06.2023	SD	EOC	EOC
P06	ISSUE	22.06.2023	GBR	EOC	EOC
P07	ISSUE	30.08.2023	SD	GBR	EOC

AECOM - Roughan & O'Donovan Alliance

ROD
ROUGHAN & O'DONOVAN
CONSULTING ENGINEERS
ARENA HOUSE, ARENA ROAD,
SANDYFORD, DUBLIN 18
D18 V8P6, IRELAND

Drawn: AG | Designed: DN | Checked: EOC | Approved: SMG | Status: S2 - Planning

Project Title: Royal Canal Greenway Cycle And Pedestrian Route Phase 4 Phibsborough to Ashtown - Amending Part VIII						
Drawing Title: SITE LAYOUT PLAN SHEET 02 OF 04						
Drawing Number	Project	Originator	Volume	Location	Type	Role
RCP4	RCP4	ROD	HGN	4B_AE	DR	CH
Scale (A1)	1:500	Date	FEB 22	Job No.	18.152	Rev.
						P07

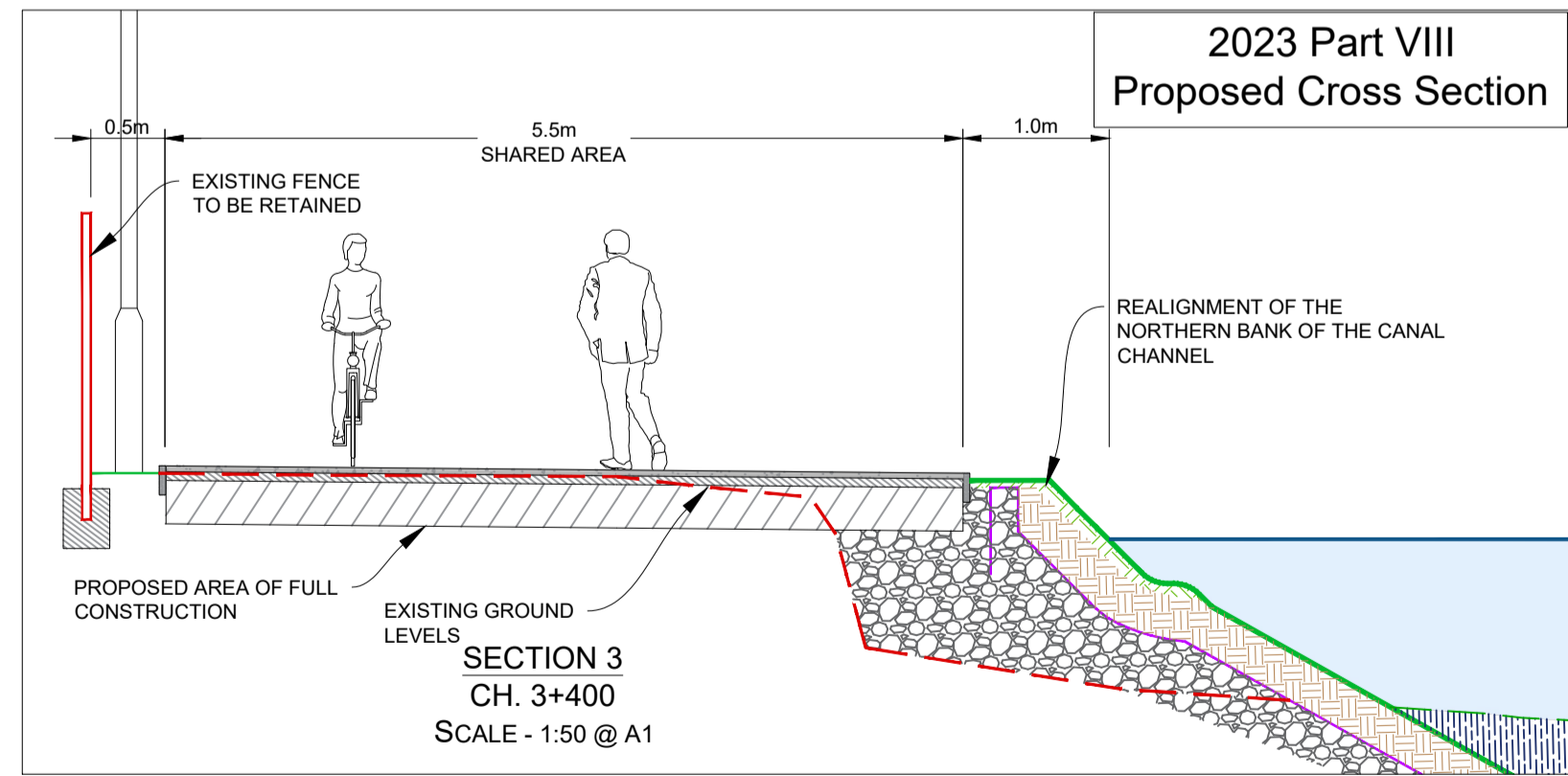
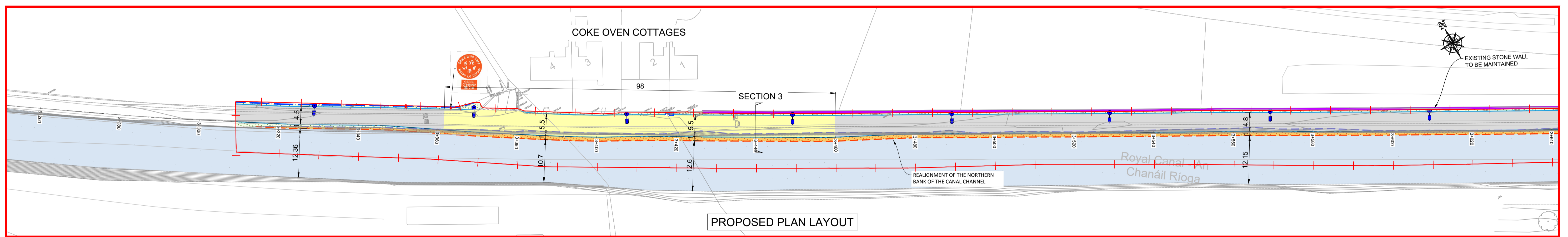
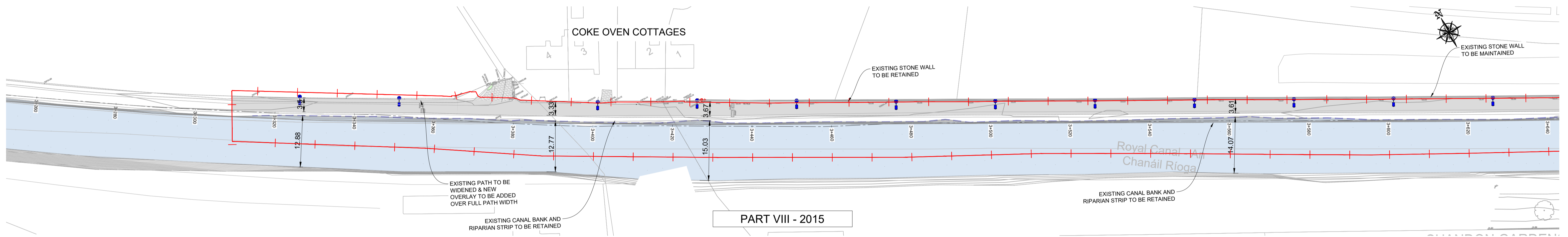
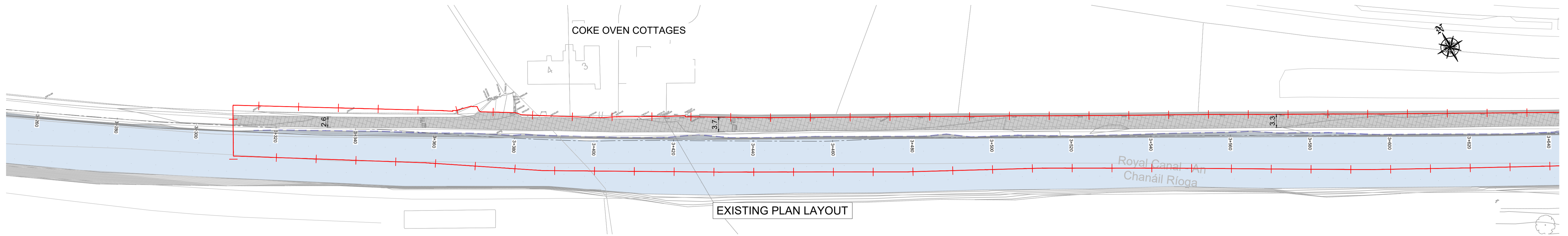

PLAN VIEWS LEGEND:

	EXISTING FOOTPATHS		PROPOSED 45° SPLAY KERB		PROPOSED SIGN
	PROPOSED GREENWAY SURFACE		PROPOSED LANDSCAPING		NEW CANAL EDGE
	PROPOSED SHARED SURFACE		PROPOSED NEW CANAL EMBANKMENT VERGE		EXISTING CANAL EDGE
	PROPOSED BUFF SURFACE		PROPOSED FENCE TYPE A		EXISTING CALP WALL TO BE RETAINED
	ROYAL CANAL NAVIGATION CHANNEL		PROPOSED PALADIN FENCE		LAND ACQUISITION LINE PROPOSED UNDER 2015 PART VIII
	PROPOSED CCTV POLE		PROPOSED STEEL PALISADE SECURITY FENCE		PROPOSED WIDENING UNDER 2015 PART VIII
	PROPOSED PUBLIC LIGHTING		TREES TO BE RETAINED		TOPSOIL LAYER
	AREA PROVIDED BY THE EMPLOYER		PROPOSED BOLLARD		
	PROPOSED WOODEN KERB				
	PROPOSED EMBANKMENT PROFILE		PROPOSED HDPE LINER		
	PROPOSED FINISHED CANAL PROFILE		PUDDLE CLAY LAYER		

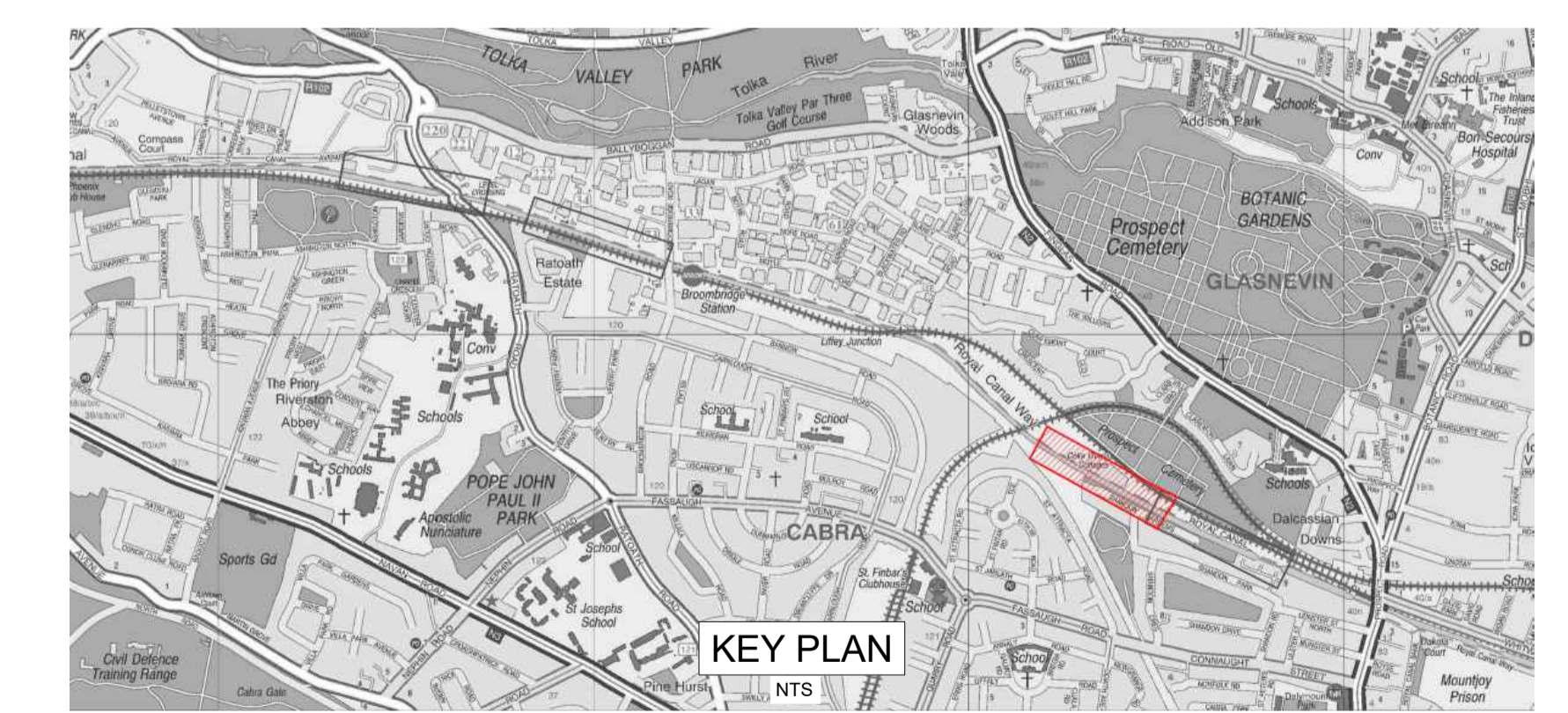

No.	Revision	Date	By	Chkd	App'd
P02	ISSUE	17.03.2023	GBR	EOC	EOC
P03	ISSUE	30.03.23	EOC	EOC	EOC
P04	ISSUE	19.05.2023	GBR	EOC	EOC
P05	ISSUE	09.06.2023	SD	EOC	EOC
P06	ISSUE	22.06.2023	GBR	EOC	EOC
P07	ISSUE	30.08.2023	SD	GBR	EOC

AECOM - Roughan & O'Donovan Alliance

ROD
ROUGHAN & O'DONOVAN
CONSULTING ENGINEERS
ARENA HOUSE, ARENA ROAD,
SANDYFORD, DUBLIN 18
D18 V8P6, IRELAND

Project Title		Royal Canal Greenway Cycle And Pedestrian Route Phase 4 Phibsborough to Ashtown - Amending Part VIII					
Drawing Title		SITE LAYOUT PLAN SHEET 03 OF 04					
Project Number	Originator	Volume	Location	Type	Role	Number	
RCP4	ROD	HGN	4B_AE	DR	CH	400003	
Scale (A1)	1:500	Date	FEB 22	Job No.	18.152	Rev.	P07

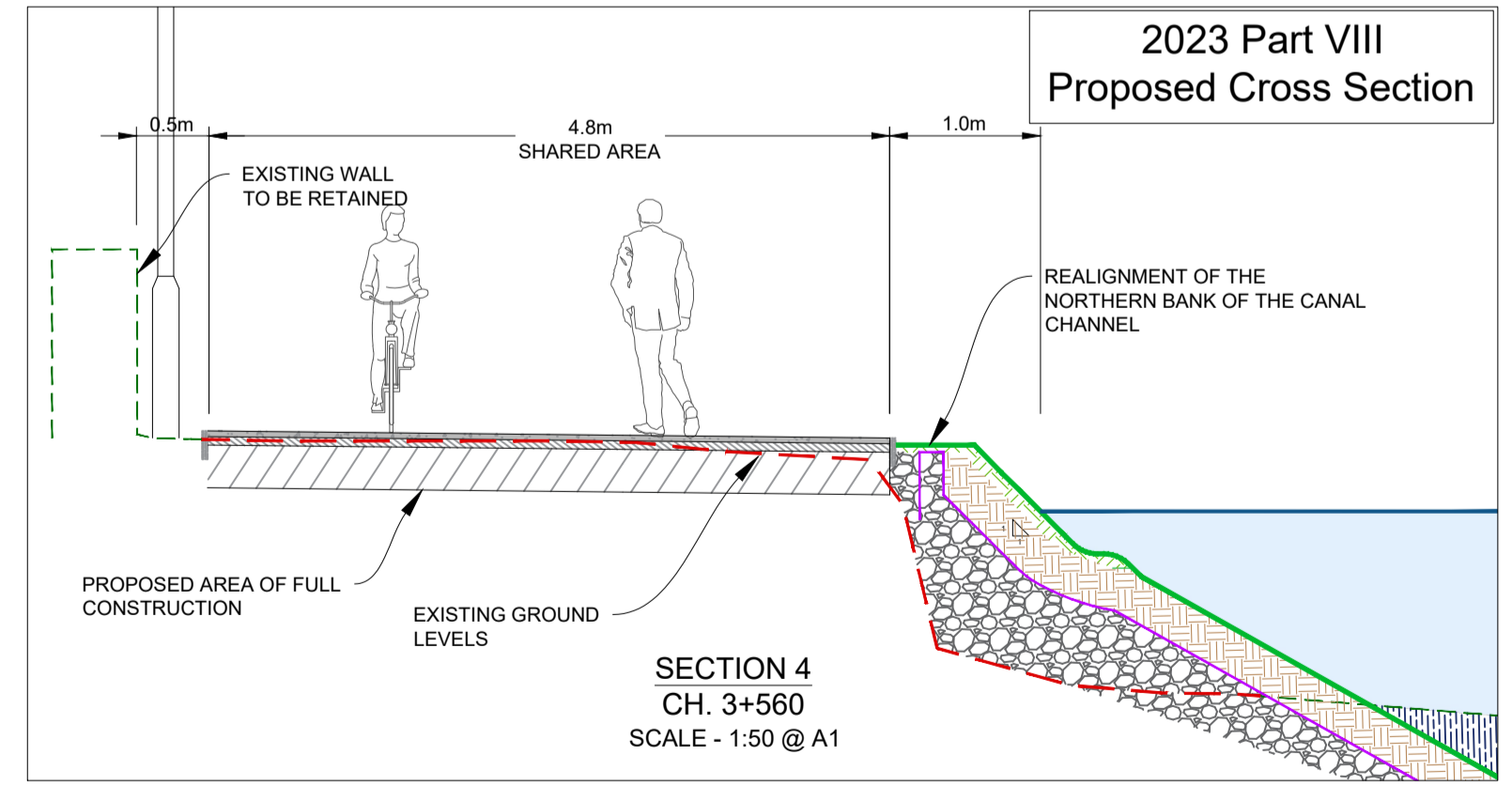
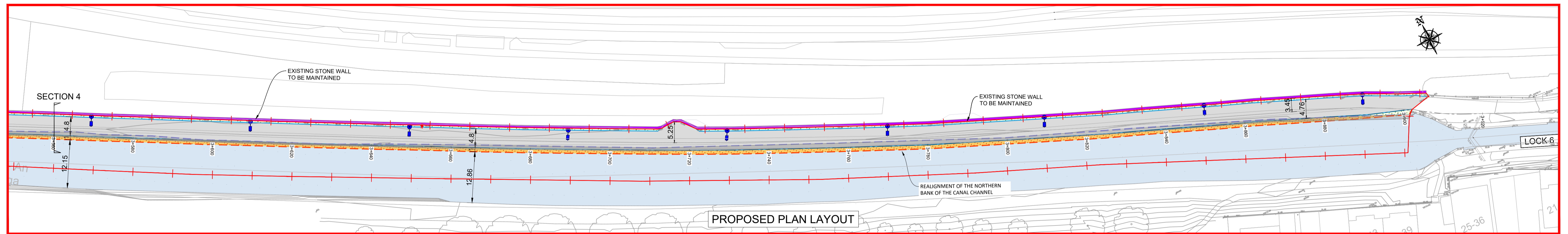
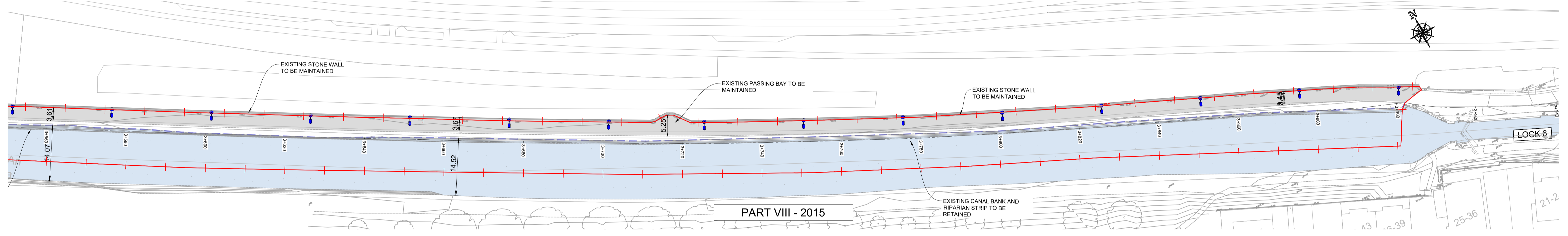
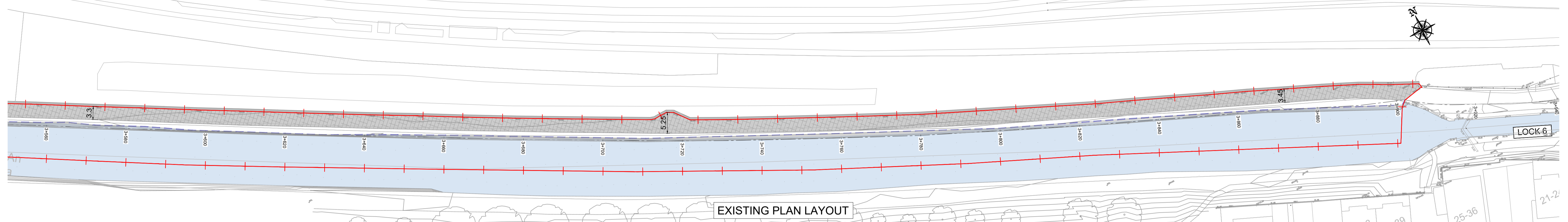

PLAN VIEWS LEGEND:

	EXISTING FOOTPATHS		PROPOSED 45° SPLAY KERB		PROPOSED SIGN
	PROPOSED GREENWAY SURFACE		PROPOSED LANDSCAPING		NEW CANAL EDGE
	PROPOSED SHARED SURFACE		PROPOSED NEW CANAL EMBANKMENT VERGE		EXISTING CANAL EDGE
	PROPOSED BUFF SURFACE		PROPOSED FENCE TYPE A		EXISTING CALP WALL TO BE RETAINED
	ROYAL CANAL NAVIGATION CHANNEL		PROPOSED PALADIN FENCE		LAND ACQUISITION LINE PROPOSED UNDER 2015 PART VIII
	PROPOSED CCTV POLE		PROPOSED STEEL PALISADE SECURITY FENCE		PROPOSED WIDENING UNDER 2015 PART VIII
	PROPOSED PUBLIC LIGHTING		TREES TO BE RETAINED		TOPSOIL LAYER
	AREA PROVIDED BY THE EMPLOYER		PROPOSED BOLLARD		
	PROPOSED WOODEN KERB				
	PROPOSED HDPE LINER				
	PROPOSED FINISHED CANAL PROFILE		PUDDLE CLAY LAYER		

SECTIONS LEGEND:

	PROPOSED EMBANKMENT PROFILE
	PROPOSED FINISHED CANAL PROFILE

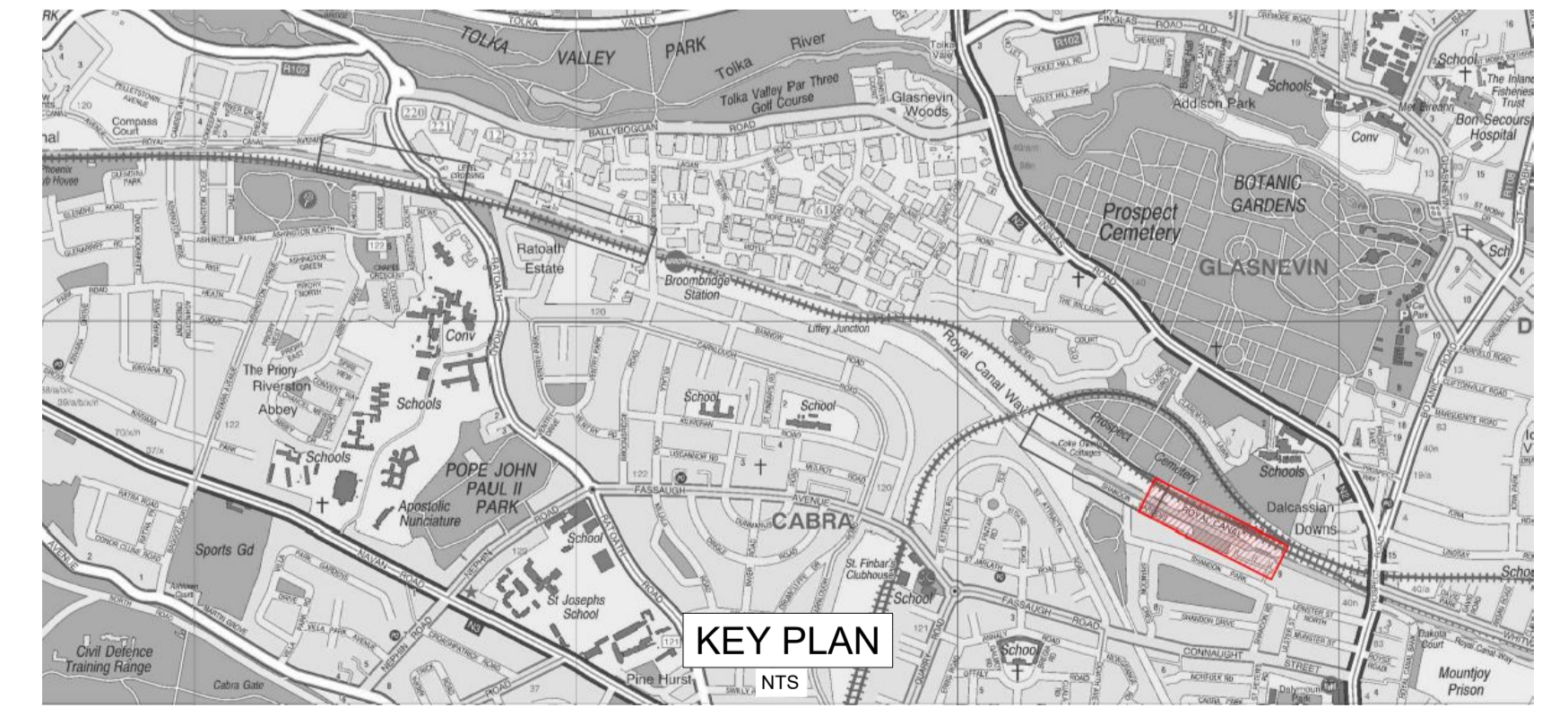

No.	Revision	Date	By	Chkd	App'd
P02	ISSUE	17.03.2023	GBR	EOC	EOC
P03	ISSUE	30.03.23	EOC	EOC	EOC
P04	ISSUE	19.05.2023	GBR	EOC	EOC
P05	ISSUE	09.06.2023	SD	EOC	EOC
P06	ISSUE	22.06.2023	GBR	EOC	EOC
P07	ISSUE	30.08.2023	SD	GBR	EOC

AECOM - Roughan & O'Donovan Alliance



ROUGHAN & O'DONOVAN CONSULTING ENGINEERS
ARENA HOUSE, ARENA ROAD,
SANDYFORD, DUBLIN 18
D18 V8P6, IRELAND

Project Title: Royal Canal Greenway Cycle And Pedestrian Route Phase 4 Phibsborough to Ashtown - Amending Part VIII

Drawing Title: SITE LAYOUT PLAN SHEET 04 OF 04

Drawing Number	Project	Originator	Volume	Location	Type	Role	Number
RCP4	-	ROD	-	HGN	-	4B_AE	-
						DR	-
						CH	-
							400004

Scale (A1)	1:500	Date	FEB 22	Job No.	18.152	Rev.	P07
------------	-------	------	--------	---------	--------	------	-----

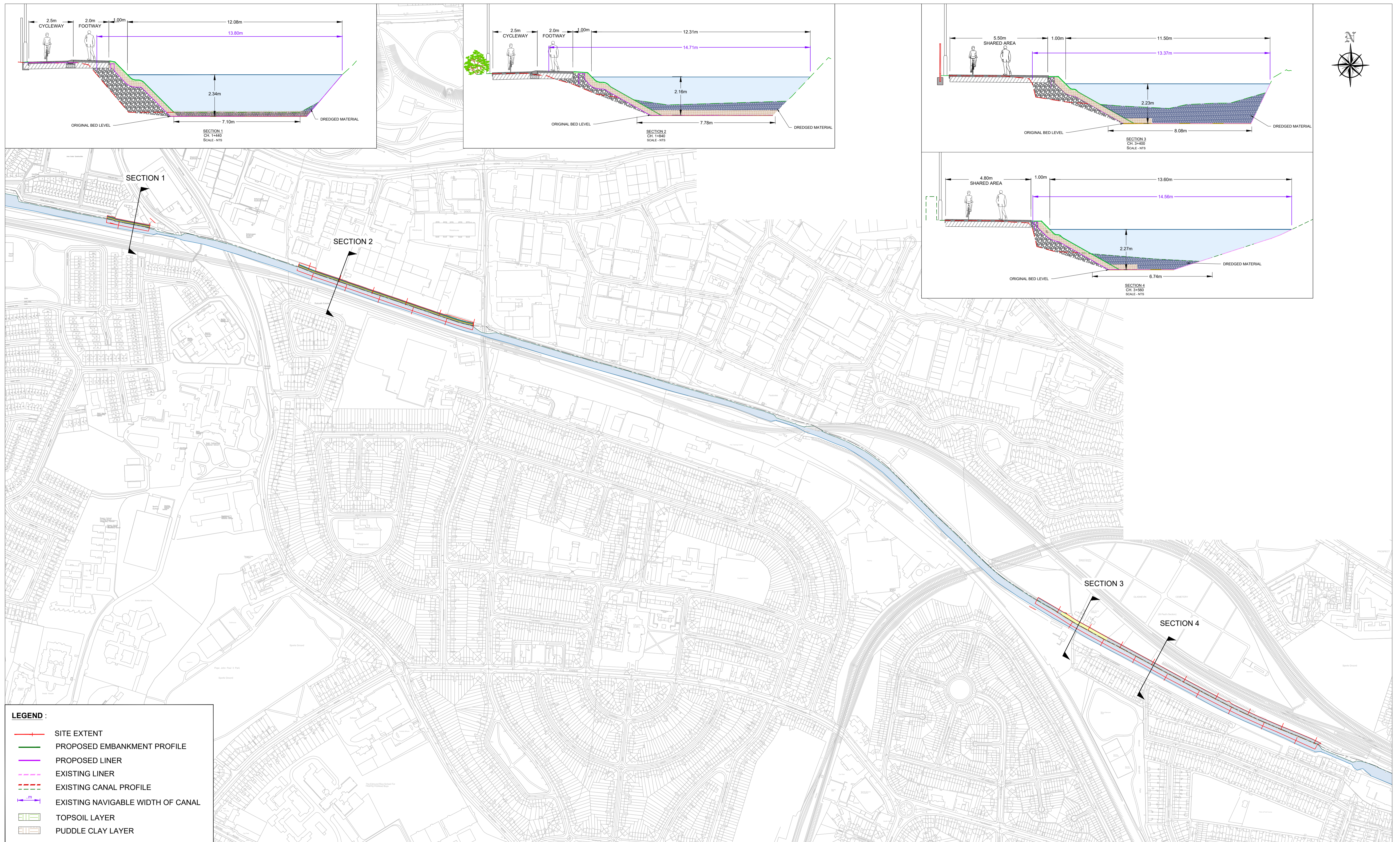

LEGEND :

- SITE EXTENT
- PROPOSED EMBANKMENT PROFILE
- PROPOSED LINER
- - - EXISTING LINER
- - - EXISTING CANAL PROFILE
- EXISTING NAVIGABLE WIDTH OF CANAL
- TOPSOIL LAYER
- PUDDLE CLAY LAYER

No.	Revision	Date	By	Chkd	App'd
P03	ISSUE	17.03.2023	GBR	EOC	EOC
P04	ISSUE	15.06.2023	GBR	EP	EOC

AECOM - Roughan & O'Donovan Alliance

ROUGHAN & O'DONOVAN
CONSULTING ENGINEERS
ARENA HOUSE, ARENA ROAD,
SANDYFORD, DUBLIN 18
D18 V8P6, IRELAND

Project Title		Royal Canal Greenway Cycle And Pedestrian Route Phase 4 Phibsborough to Ashtown - Amending Part VIII					
Drawing Title		TYPICAL CROSS SECTIONS					
Project	Originator	Volume	Location	Type	Role	Number	
RCP4	ROD	GEN	4B_AE	DR	CH	400300	
Scale (A1)	NTS	Date:	FEB 22	Job No:	18.152	Rev:	P04

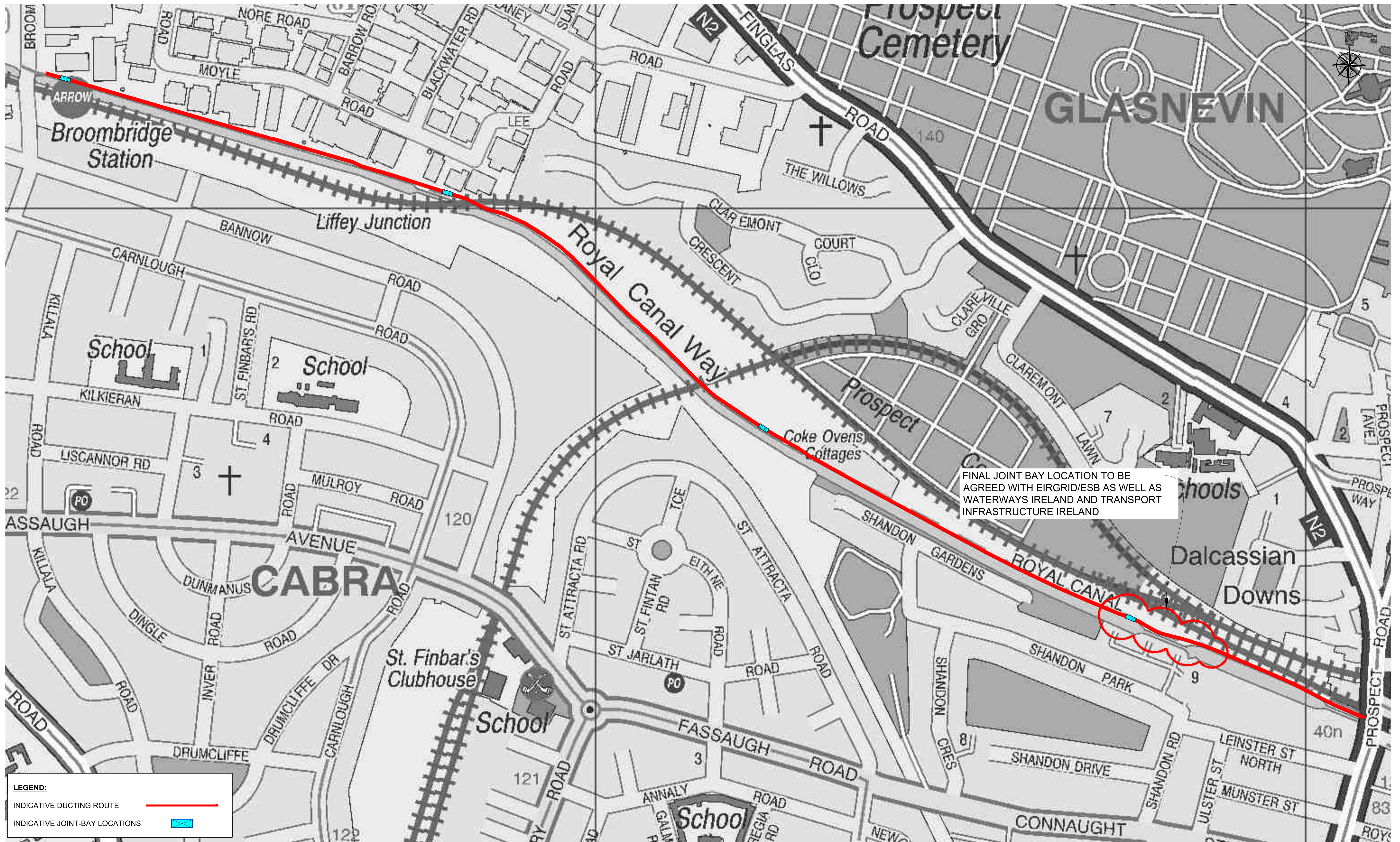

LEGEND:

INDICATIVE DUCTING ROUTE 

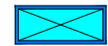
INDICATIVE JOINT-BAY LOCATIONS 



Tionscaldal Éireann
Project Ireland
2040



Comhairle Cathrach
Bhaile Átha Cliath
Dublin City Council



NTA
Údarás Náisiúnta Iompair
National Transport Authority

No.	Revision	Date	By	Chkd	App'd
P01	JOINT BAYS 3 AND 4 MOVED	25.08.2022	GBR	DN	EOC
P02	ISSUE	17.03.2023	GBR	EOC	EOC
P03	ISSUE	31.05.2023	GBR	EOC	EOC

AECOM - Roughan & O'Donovan Alliance



ROD
ROUGHAN & O'DONOVAN
CONSULTING ENGINEERS
ARENA HOUSE, ARENA ROAD,
SANDYFORD, DUBLIN 18
D18 V8P6, IRELAND

Project Title: Royal Canal Greenway Cycle And Pedestrian Route Phase 4 Phibsborough to Ashtown - Amending Part VIII						
Drawing Title: ENERGY RESILIENCE INFRASTRUCTURE						
Project	Originator	Volume	Location	Type	Role	Number
RCP4	ROD	UES	4B_AE	DR	CH	400500
Scale (A1)	1:2,500	Date:	JUL 22	Job No:	18.152	Rev: P03

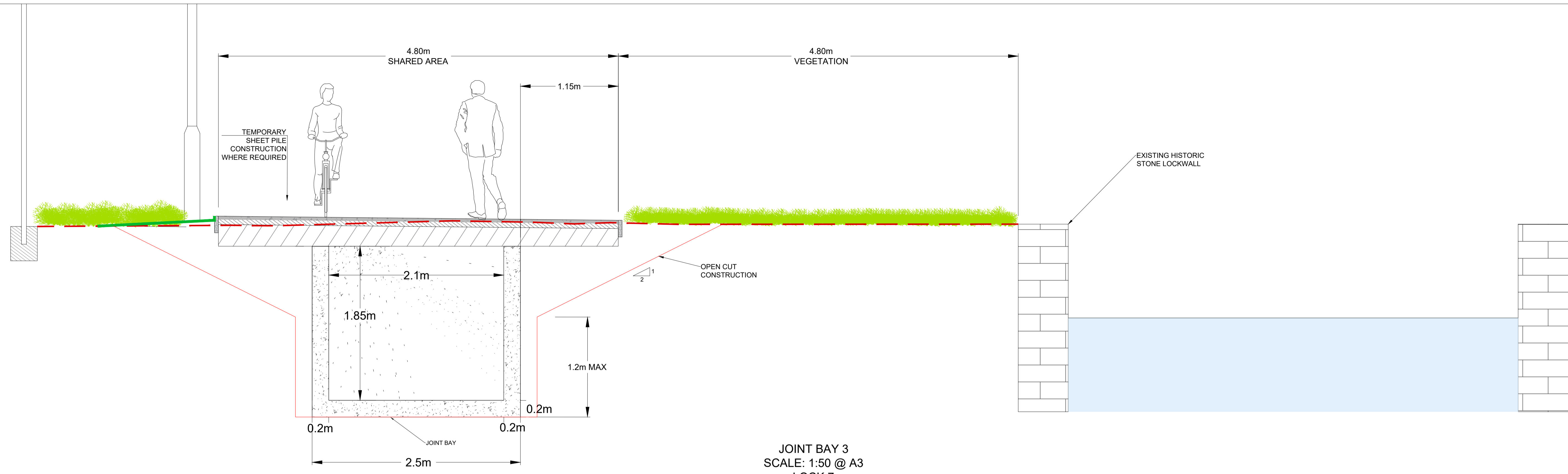

JOINT BAY 3
SCALE: 1:50 @ A3
LOCK 7
CH. 2+740

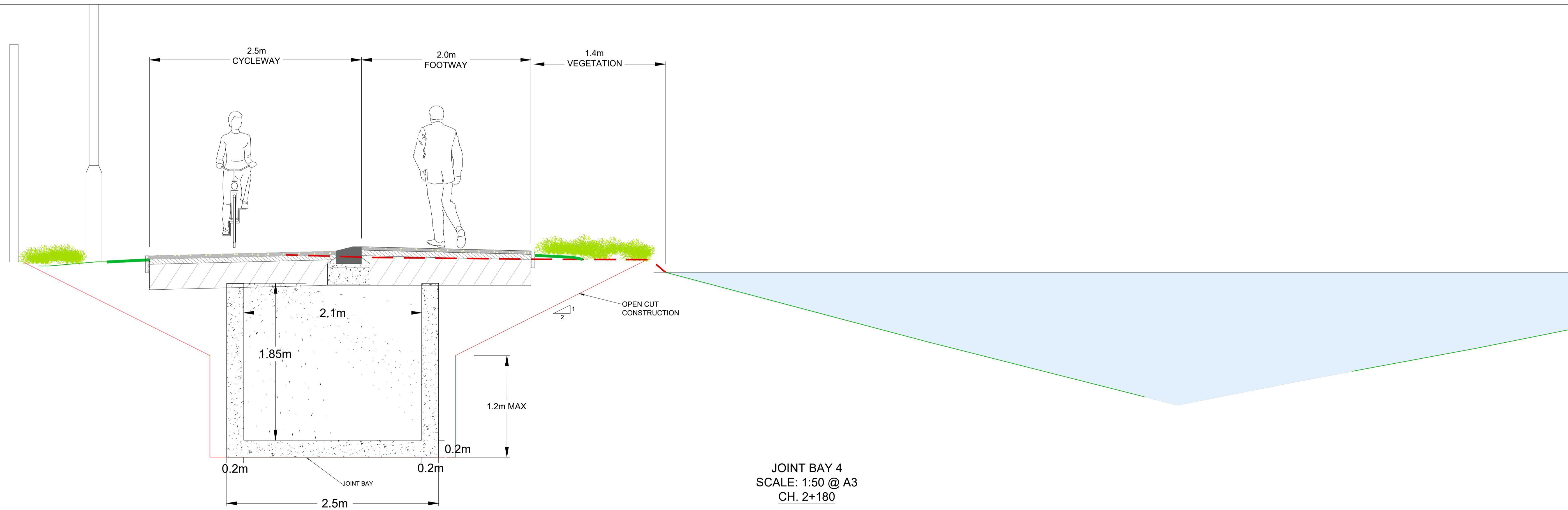

JOINT BAY 4
SCALE: 1:50 @ A3
CH. 2+180



No.	Revision	Date	By	Chkd	App'd
P01	ISSUE	04.04.2023	GBR	EOC	EOC
P02	ISSUE	06.06.2023	GBR	EOC	EOC

AECOM - Roughan & O'Donovan Alliance



ROUGHAN & O'DONOVAN
CONSULTING ENGINEERS
ARENA HOUSE, ARENA ROAD,
SANDYFORD, DUBLIN 18
D18 V8P6, IRELAND

Project Title Royal Canal Greenway Cycle And Pedestrian Route Phase 4 Phibsborough to Ashtown - Amending Part VIII						
Drawing Title JOINT BAY TYPICAL CROSS SECTION SHEET 01 OF 02						
Project	Originator	Volume	Location	Type	Role	Number
RCP4	RODA	HML	4B_AE	DR	CH	400101
Scale (A1)	1:50 @ A3	Date	MARCH 2023	Job No.	18.152	Rev. P02

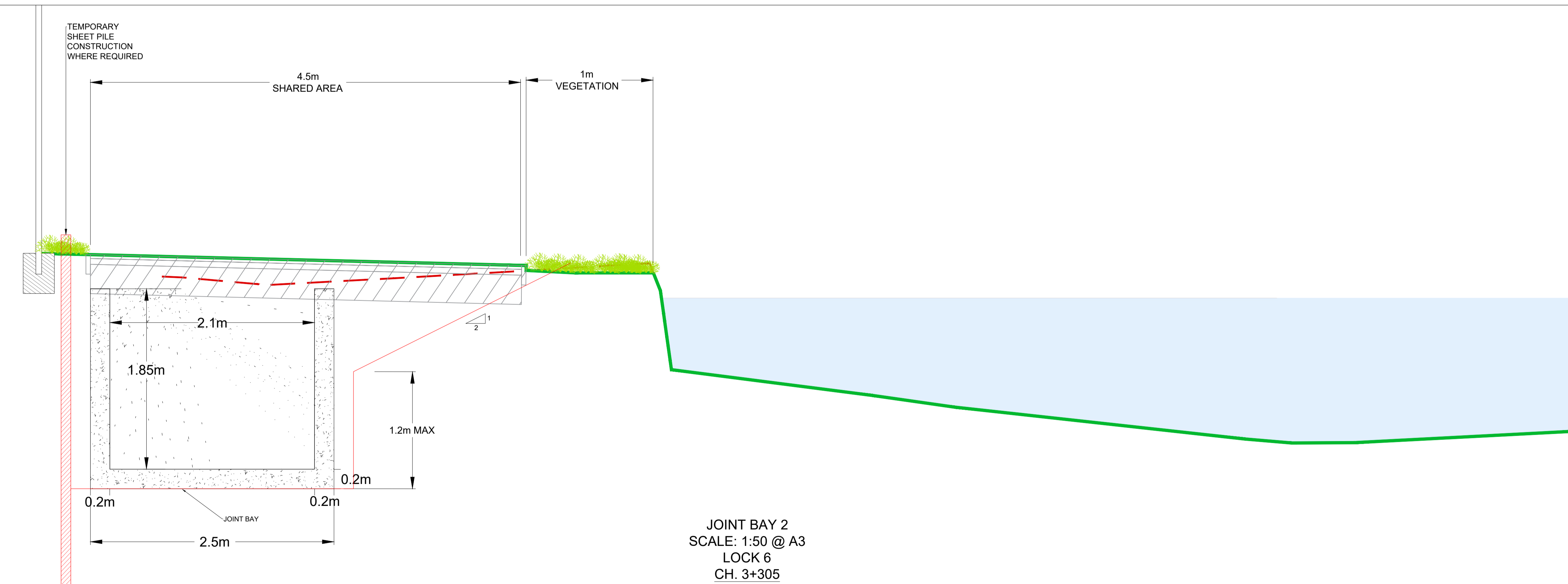
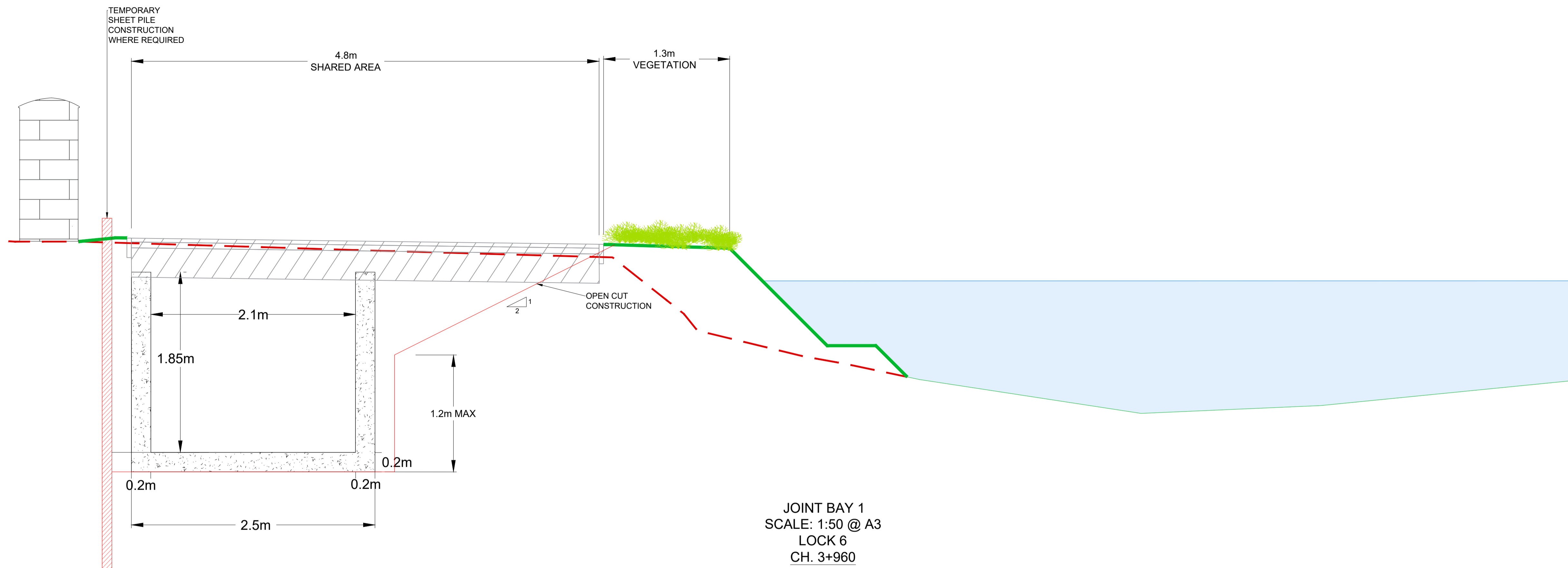

No.	Revision	Date	By	Chkd	App'd
P01	ISSUE	04.04.2023	GBR	EOC	EOC
P02	ISSUE	06.06.2023	GBR	EOC	EOC

AECOM - Roughan & O'Donovan Alliance



ROUGHAN & O'DONOVAN
CONSULTING ENGINEERS
ARENA HOUSE, ARENA ROAD,
SANDYFORD, DUBLIN 18
D18 V8P6, IRELAND

Project Title: Royal Canal Greenway Cycle And Pedestrian Route Phase 4 Phibsborough to Ashtown - Amending Part VIII

Drawing Title: JOINT BAY TYPICAL CROSS SECTION SHEET 02 OF 02

Project	Originator	Volume	Location	Type	Role	Number
RCP4	RODA	HML	4B_AE	DR	CH	400102

Drawn: SD	Designed: EOC	Checked: EOC	Approved: SMG	Status: S2 - Planning	Scale (A1): 1:50 @ A3	Date: MARCH 2023	Job No: 18.152	Rev: P02
-----------	---------------	--------------	---------------	-----------------------	-----------------------	------------------	----------------	----------

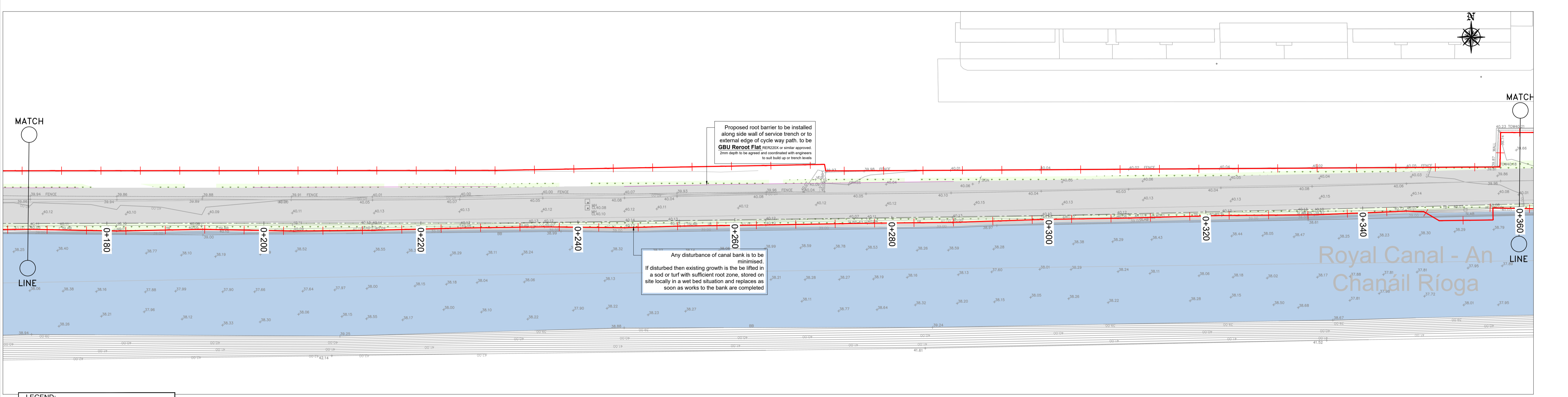
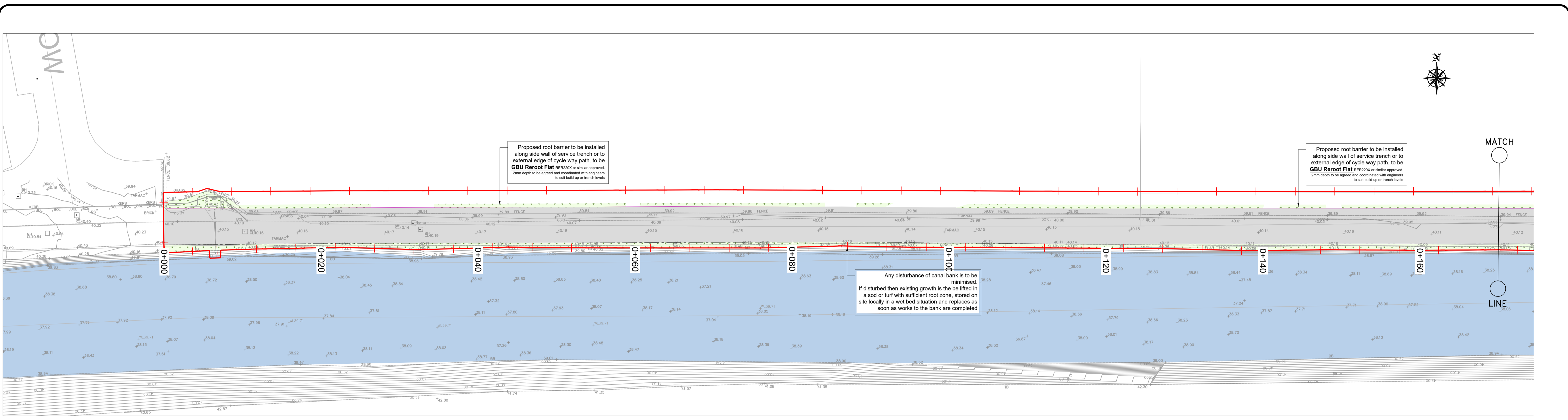

LEGEND:

- PROPOSED GREENWAY
- PROPOSED BUFF AREA
- ROYAL CANAL CHANNEL
- AREA PROVIDED BY THE EMPLOYER
- PROPOSED RETAINING WALL
- PROPOSED ROOT BARRIER
- GRASS AREA
- PLANTING HEDGE
- TREES TO BE RETAINED
- PROPOSED TREES
- TREES TO BE REMOVED



No.	Revision	Date	By	Chk'd	App'd
P02	ISSUE	13.06.2023	GBR	EOC	EOC

AECOM - Roughan & O'Donovan Alliance

ROD
ROUGHAN & O'DONOVAN

AECOM

ROUGHAN & O'DONOVAN CONSULTING ENGINEERS
ARENA HOUSE, ARENA ROAD,
SANDYFORD, DUBLIN 18
D18 V8P6, IRELAND

Project Title		Royal Canal Greenway Cycle And Pedestrian Route Phase 4 Phibsborough to Ashtown - Amending Part VIII					
Drawing Title		LANDSCAPING SHEET 01 OF 13					
Project Number	Originator	Volume	Location	Type	Role	Number	
RCP4	ROD	ELS	4B_AE	DR	CH	403101	
Scale (A1)	1:250	Date	MARCH 22	Job No:	18.152	Rev:	P02

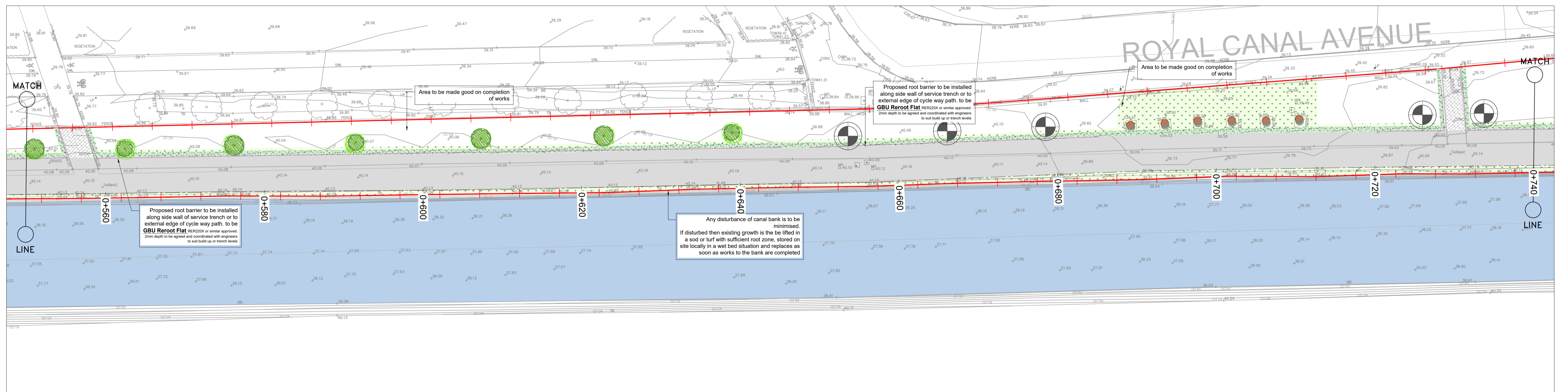
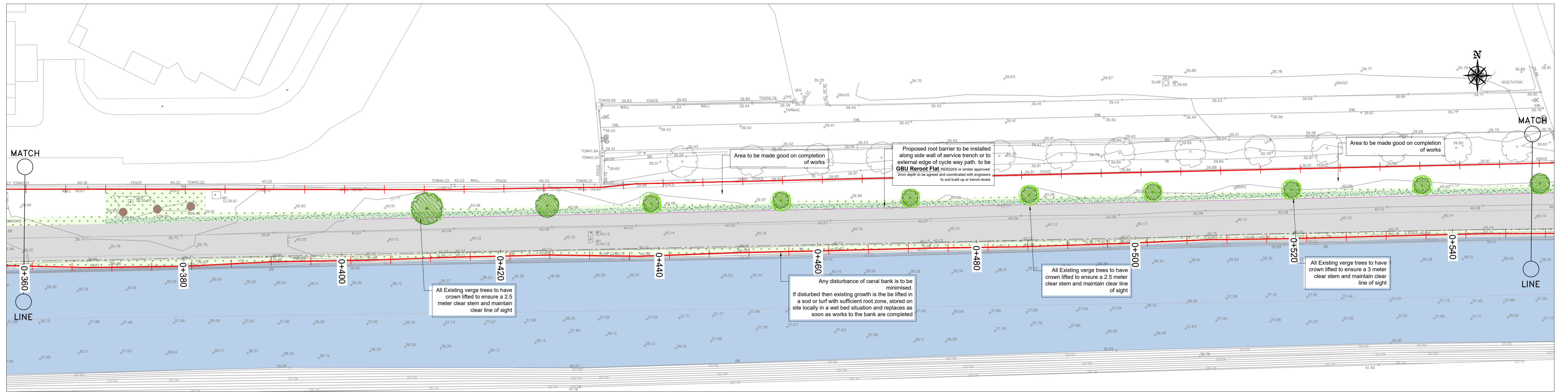

LEGEND:

- PROPOSED GREENWAY
- PROPOSED BUFF AREA
- ROYAL CANAL CHANNEL
- AREA PROVIDED BY THE EMPLOYER
- PROPOSED RETAINING WALL
- PROPOSED ROOT BARRIER
- GRASS AREA
- PLANTING HEDGE
- TREES TO BE RETAINED
- PROPOSED TREES
- TREES TO BE REMOVED



No.	Revision	Date	By	Chkd	App'd
P02	ISSUE	13.06.2023	GBR	EOC	EOC

AECOM - Roughan & O'Donovan Alliance		ROYAL CANAL GREENWAY CYCLE AND PEDESTRIAN ROUTE PHASE 4 PHIBSBOROUGH TO ASHTOWN - AMENDING PART VIII	
ROUGHAN & O'DONOVAN CONSULTING ENGINEERS ARENA HOUSE, ARENA ROAD, SANDYFORD, DUBLIN 18 D18 V8P6, IRELAND		LANDSCAPING SHEET 02 OF 13 Project Originator Volume Location Type Role Number RCP4 - ROD - ELS - 4B_AE - DR - CH - 403102	
Drawn: AG	Designed: EOC	Checked: EOC	Approved: SMG
Status: S2 - Planning	Scale (A1): 1:250	Date: MARCH 22	Job No: 18.152
Rev: P02			

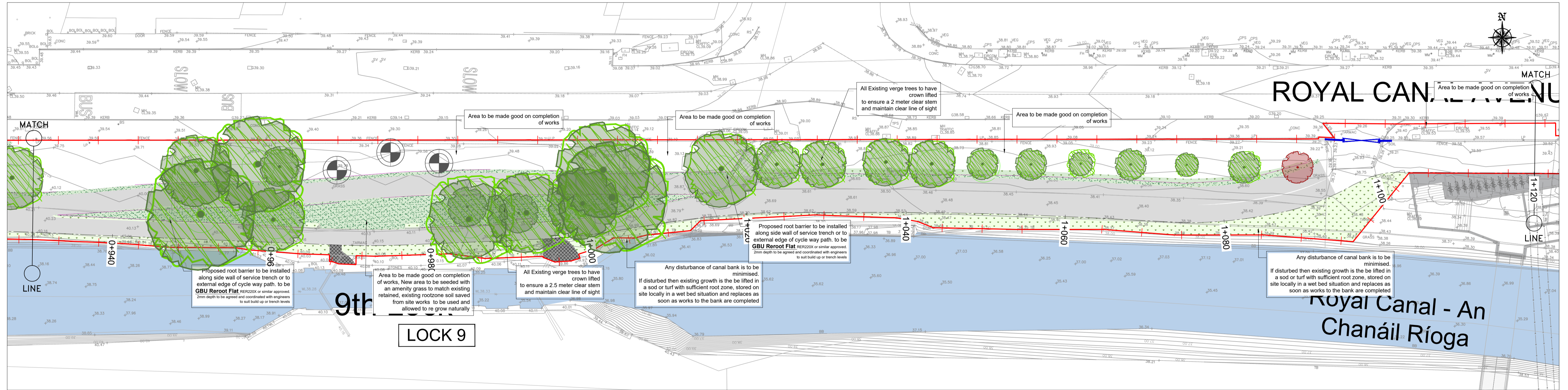
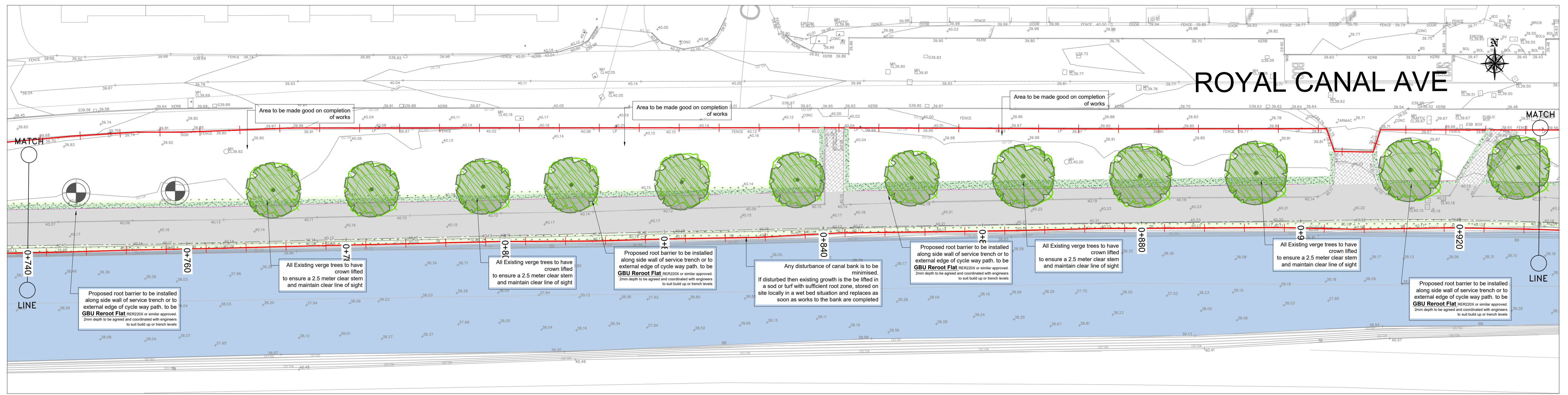

LEGEND:

- PROPOSED GREENWAY
- PROPOSED BUFF AREA
- ROYAL CANAL CHANNEL
- AREA PROVIDED BY THE EMPLOYER
- PROPOSED RETAINING WALL
- PROPOSED ROOT BARRIER
- GRASS AREA
- PLANTING HEDGE
- TREES TO BE RETAINED
- PROPOSED TREES
- TREES TO BE REMOVED



No.	Revision	Date	By	Chkd	App'd
P02	ISSUE	13.06.2023	GBR	EOC	EOC

AECOM - Roughan & O'Donovan Alliance

ROD
ROUGHAN & O'DONOVAN
CONSULTING ENGINEERS
ARENA HOUSE, ARENA ROAD,
SANDYFORD, DUBLIN 18
D18 V8P6, IRELAND

Drawn: AG | Designed: EOC | Checked: EOC | Approved: SMG | Status: S2 - Planning

Project Title		Royal Canal Greenway Cycle And Pedestrian Route Phase 4 Phibsborough to Ashtown - Amending Part VIII			
Drawing Title		LANDSCAPING SHEET 03 OF 13			
Project Number	Originator	Volume	Location	Type	Role
RCP4	ROD	ELS	4B_AE	DR	CH
Drawing Number	403103				
Scale (A1)	1:250	Date	MARCH 22	Job No.	18.152
Rev.	P02				

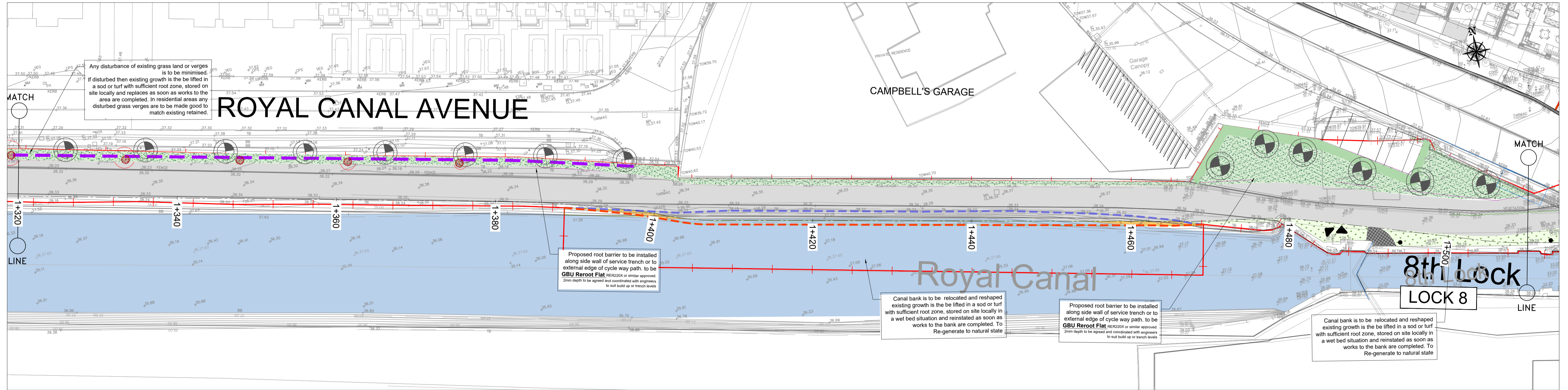
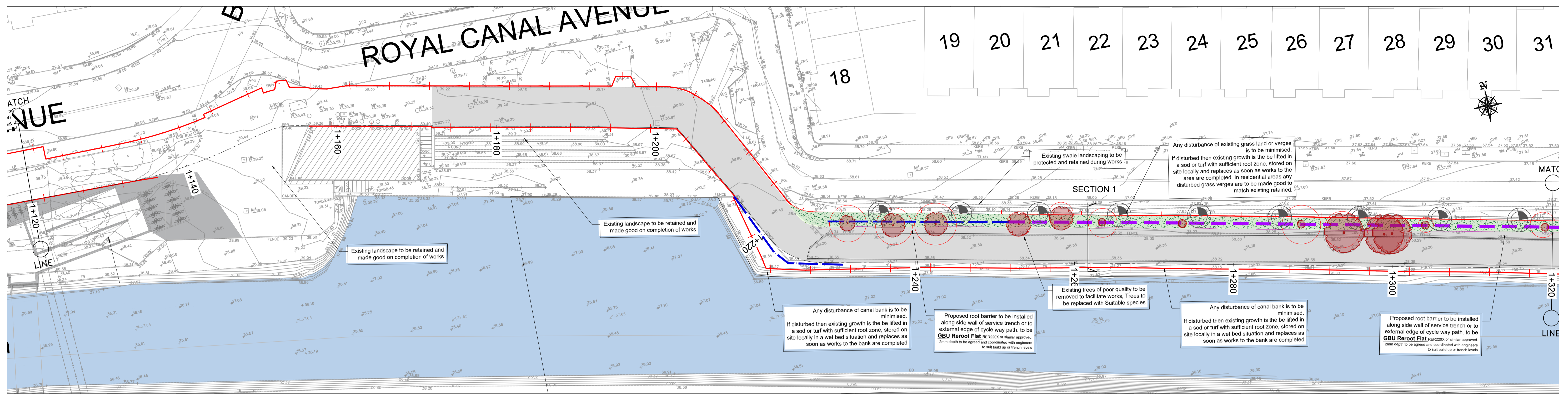

- LEGEND:**
- PROPOSED GREENWAY
 - PROPOSED BUFF AREA
 - ROYAL CANAL CHANNEL
 - AREA PROVIDED BY THE EMPLOYER
 - PROPOSED RETAINING WALL
 - PROPOSED ROOT BARRIER
 - GRASS AREA
 - PLANTING HEDGE
 - TREES TO BE RETAINED
 - PROPOSED TREES
 - TREES TO BE REMOVED

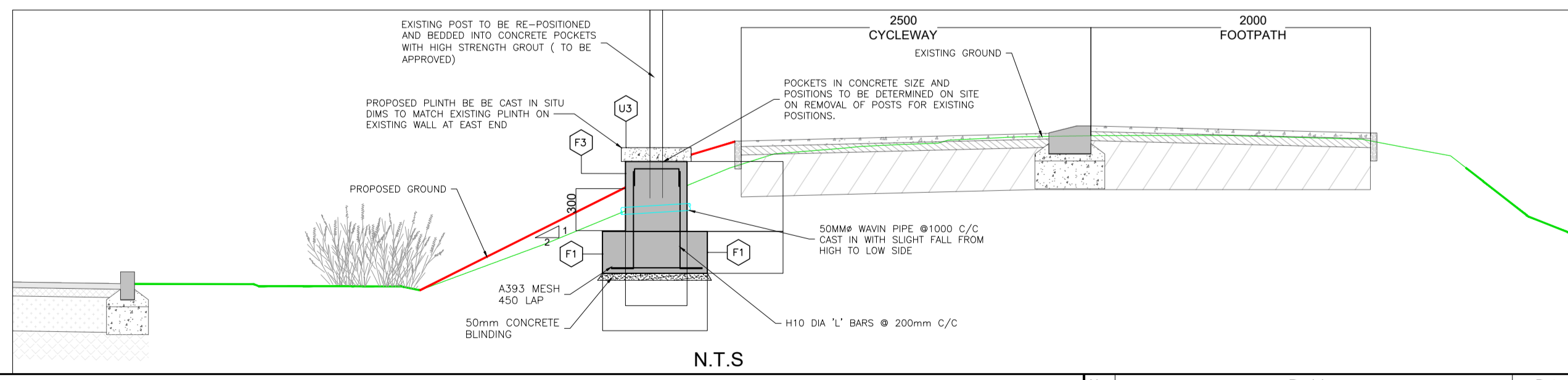

No.	Revision	Date	By	Chkd	App'd
P02	ISSUE	13.06.2023	GBR	EOC	EOC

AECOM - Roughan & O'Donovan Alliance

ROD
ROUGHAN & O'DONOVAN
AECOM

ROUGHAN & O'DONOVAN CONSULTING ENGINEERS
ARENA HOUSE, ARENA ROAD,
SANDYFORD, DUBLIN 18
D18 V8P6, IRELAND

Project Title		Royal Canal Greenway Cycle And Pedestrian Route Phase 4 Phibsborough to Ashtown - Amending Part VIII					
Drawing Title		LANDSCAPING SHEET 04 OF 13					
Project Number	Originator	Volume	Location	Type	Role	Number	
RCP4	ROD	ELS	4B_AE	DR	CH	403104	
Scale (A1)	1:250	Date	MARCH 22	Job No.	18.152	Rev.	P02

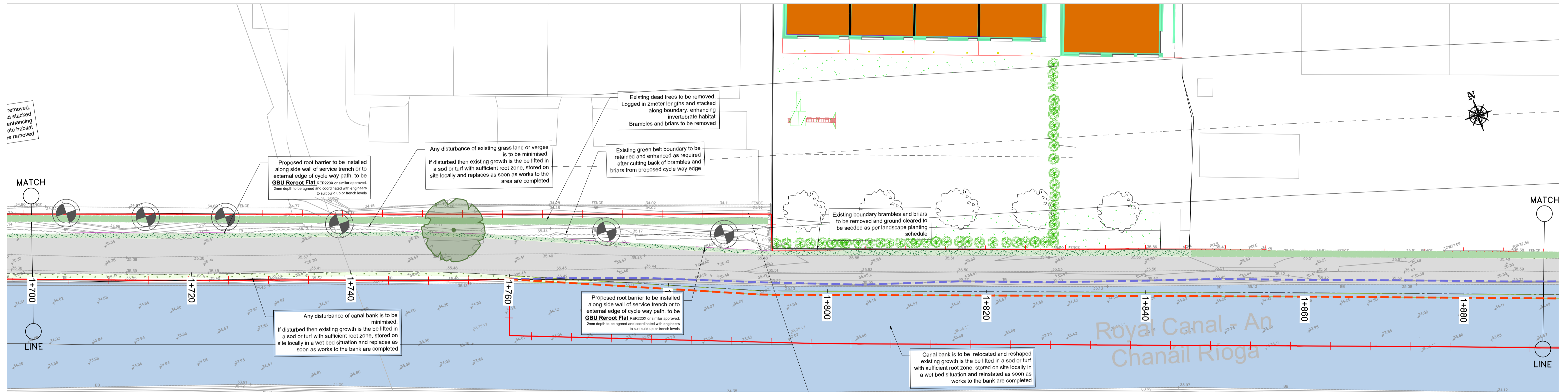
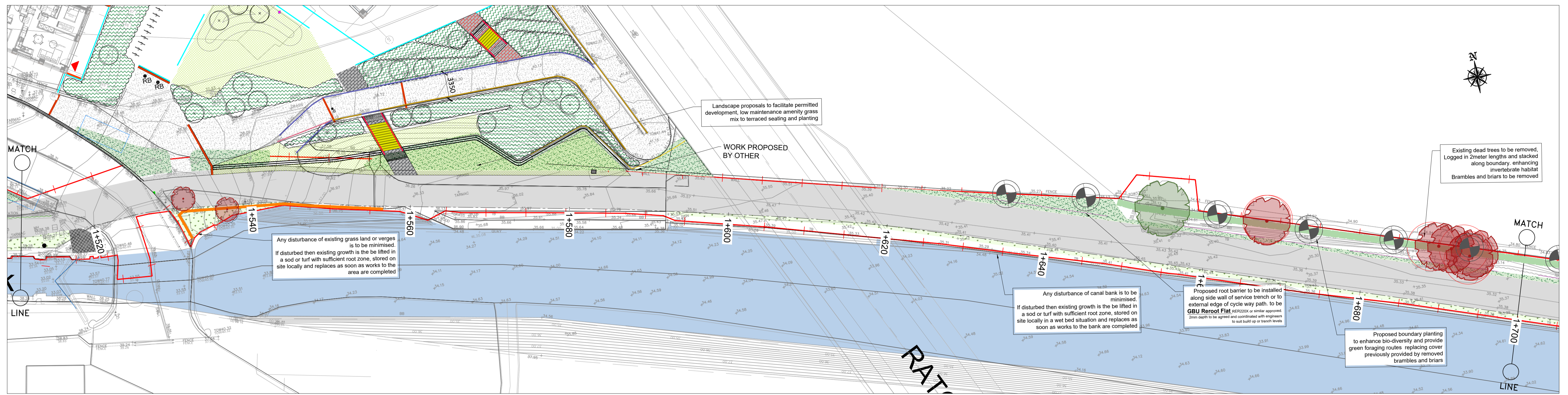

LEGEND:

- PROPOSED GREENWAY
- PROPOSED BUFF AREA
- ROYAL CANAL CHANNEL
- AREA PROVIDED BY THE EMPLOYER
- PROPOSED RETAINING WALL
- PROPOSED ROOT BARRIER
- GRASS AREA
- PLANTING HEDGE
- TREES TO BE RETAINED
- PROPOSED TREES
- TREES TO BE REMOVED



No.	Revision	Date	By	Chkd	App'd
P02	ISSUE	13.06.2023	GBR	EOC	EOC

AECOM - Roughan & O'Donovan Alliance

ROD
ROUGHAN & O'DONOVAN
CONSULTING ENGINEERS
ARENA HOUSE, ARENA ROAD,
SANDYFORD, DUBLIN 18
D18 V8P6, IRELAND

Drawn: AG | Designed: EOC | Checked: EOC | Approved: SMG | Status: S2 - Planning

Project Title: Royal Canal Greenway Cycle And Pedestrian Route Phase 4 Phibsborough to Ashtown - Amending Part VIII						
Drawing Title: LANDSCAPING SHEET 05 OF 13						
Project	Originator	Volume	Location	Type	Role	Number
RCP4	ROD	ELS	4B_AE	DR	CH	403105
Scale (A1)	1:250	Date:	MARCH 22	Job No:	18.152	Rev: P02

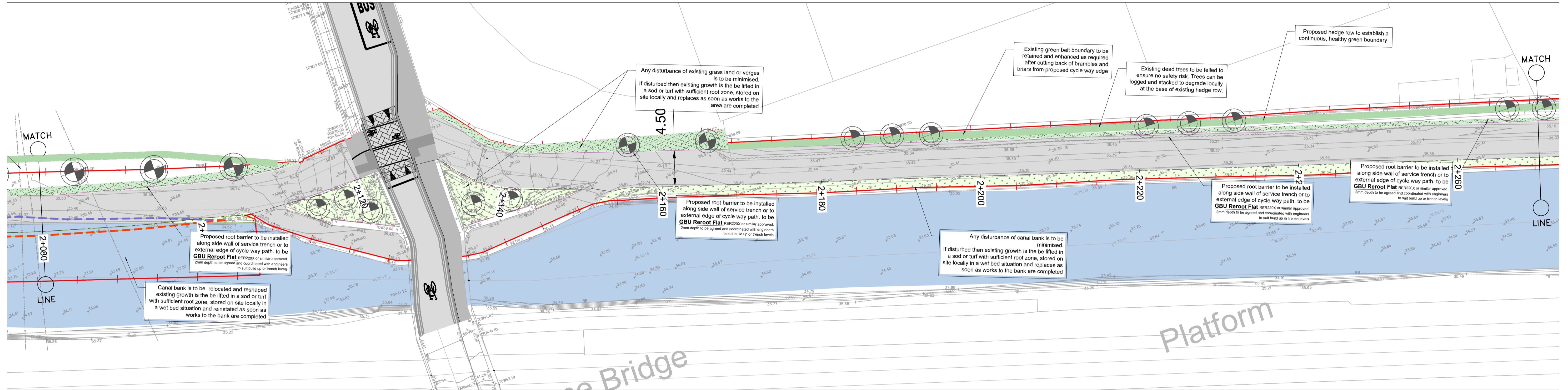
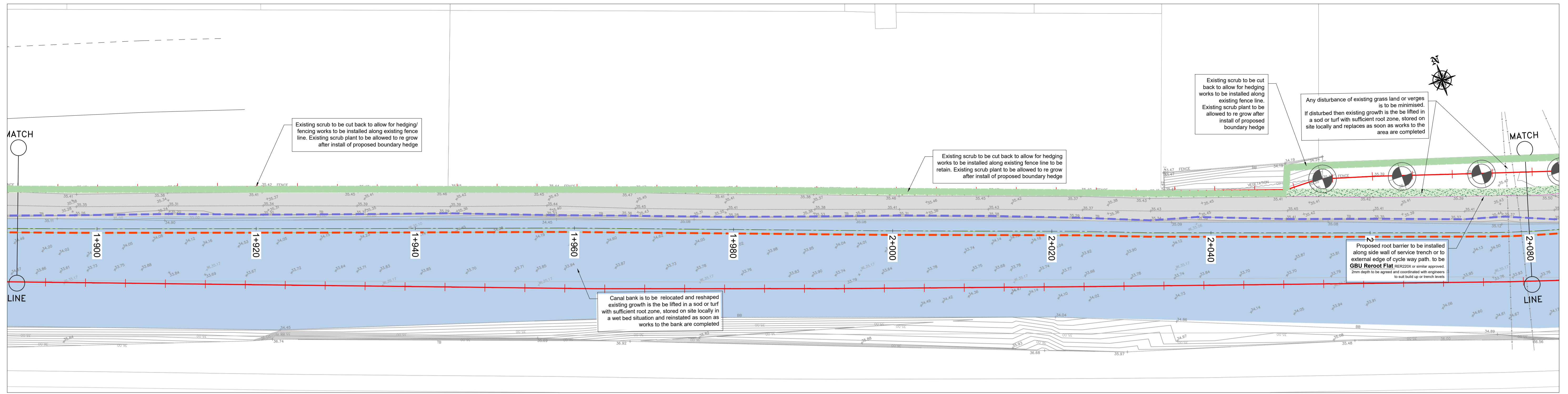

LEGEND:

- PROPOSED GREENWAY
- PROPOSED BUFF AREA
- ROYAL CANAL CHANNEL
- AREA PROVIDED BY THE EMPLOYER
- PROPOSED RETAINING WALL
- PROPOSED ROOT BARRIER
- GRASS AREA
- PLANTING HEDGE
- TREES TO BE RETAINED
- PROPOSED TREES
- TREES TO BE REMOVED



No.	Revision	Date	By	Chkd	App'd
P02	ISSUE	13.06.2023	GBR	EOC	EOC

AECOM - Roughan & O'Donovan Alliance

ROD
ROUGHAN & O'DONOVAN

AECOM

ROUGHAN & O'DONOVAN CONSULTING ENGINEERS
ARENA HOUSE, ARENA ROAD,
SANDYFORD, DUBLIN 18
D18 V8P6, IRELAND

Project Title: Royal Canal Greenway Cycle And Pedestrian Route Phase 4 Phibsborough to Ashtown - Amending Part VIII						
Drawing Title: LANDSCAPING SHEET 06 OF 13						
Drawing Number	Project	Originator	Volume	Location	Type	Role
RCP4	RCP4	ROD	ELS	4B_AE	DR	CH
Number	403106					
Scale (A1)	1:250	Date:	MARCH 22	Job No:	18.152	Rev:
						P02

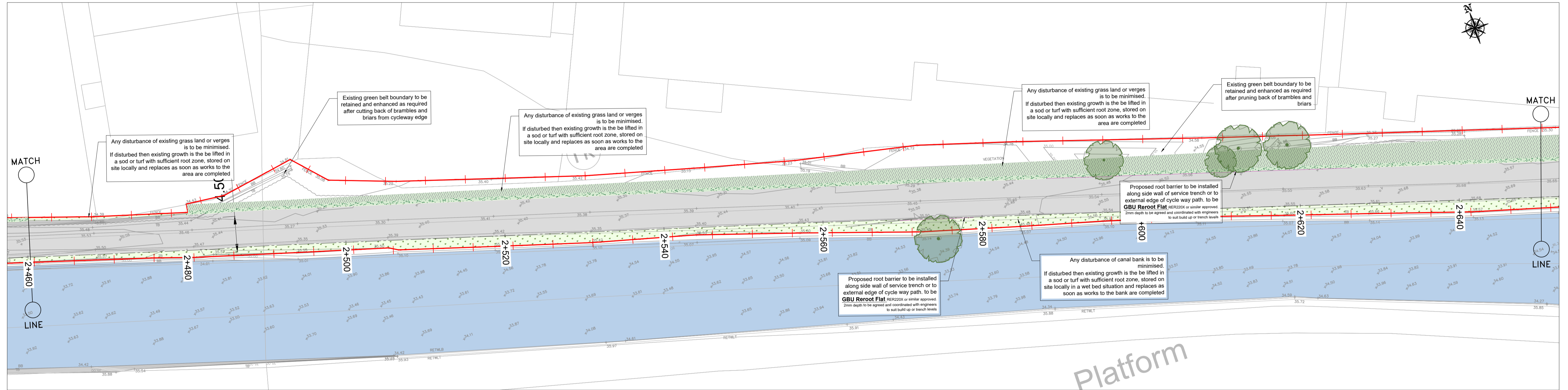
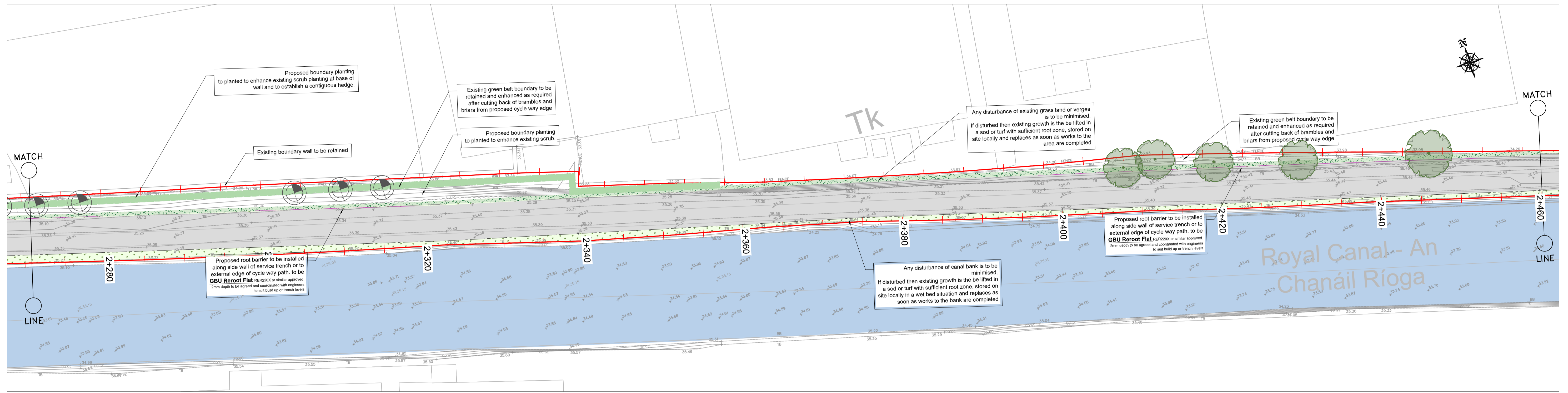

LEGEND:

- PROPOSED GREENWAY
- PROPOSED BUFF AREA
- ROYAL CANAL CHANNEL
- AREA PROVIDED BY THE EMPLOYER
- PROPOSED RETAINING WALL
- PROPOSED ROOT BARRIER
- GRASS AREA
- PLANTING HEDGE
- TREES TO BE RETAINED
- PROPOSED TREES
- TREES TO BE REMOVED



No.	Revision	Date	By	Chkd	App'd
P02	ISSUE	13.06.2023	GBR	EOC	EOC

AECOM - Roughan & O'Donovan Alliance

ROD
ROUGHAN & O'DONOVAN
CONSULTING ENGINEERS
ARENA HOUSE, ARENA ROAD,
SANDYFORD, DUBLIN 18
D18 V8P6, IRELAND

Drawn: AG | Designed: EOC | Checked: EOC | Approved: SMG | Status: S2 - Planning

Project Title: Royal Canal Greenway Cycle And Pedestrian Route Phase 4 Phibsborough to Ashtown - Amending Part VIII						
Drawing Title: LANDSCAPING SHEET 07 OF 13						
Drawing Number	Project	Originator	Volume	Location	Type	Role
RCP4	RCP4	ROD	ELS	4B_AE	DR	CH
Number	403107					
Scale (A1)	1:250	Date	MARCH 22	Job No.	18.152	Rev.
						P02

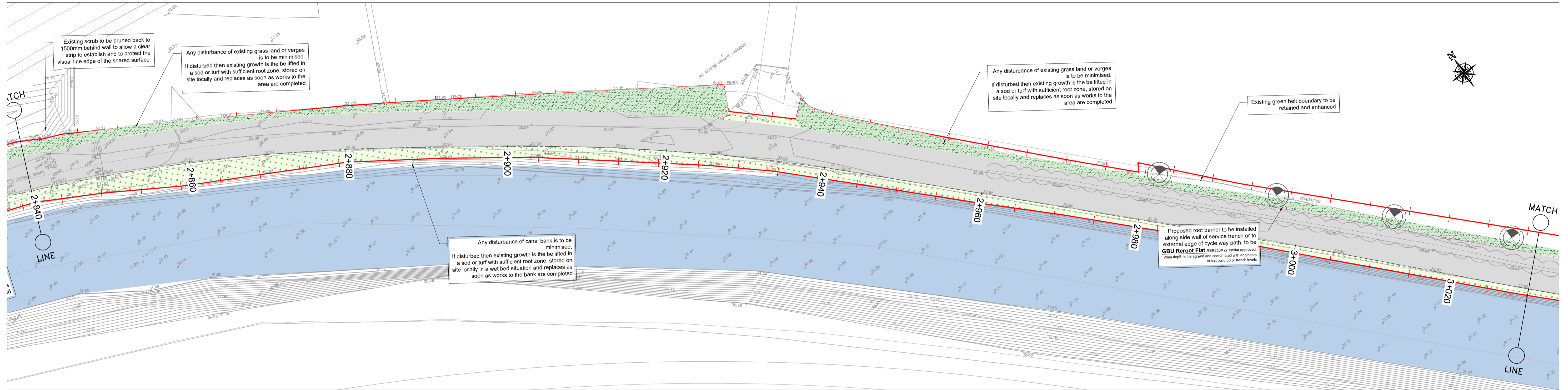

LEGEND:

- PROPOSED GREENWAY
- PROPOSED BUFF AREA
- ROYAL CANAL CHANNEL
- AREA PROVIDED BY THE EMPLOYER
- PROPOSED RETAINING WALL
- PROPOSED ROOT BARRIER
- GRASS AREA
- PLANTING HEDGE
- TREES TO BE RETAINED
- PROPOSED TREES
- TREES TO BE REMOVED



No.	Revision	Date	By	Chkd	App'd
P02	ISSUE	13.06.2023	GBR	EOC	EOC

AECOM - Roughan & O'Donovan Alliance

ROD
ROUGHAN & O'DONOVAN

AECOM

ROUGHAN & O'DONOVAN CONSULTING ENGINEERS
ARENA HOUSE, ARENA ROAD,
SANDYFORD, DUBLIN 18
D18 V8P6, IRELAND

Drawn: AG | Designed: EOC | Checked: EOC | Approved: SMG | Status: S2 - Planning

Project Title: Royal Canal Greenway Cycle And Pedestrian Route Phase 4 Phibsborough to Ashtown - Amending Part VIII						
Drawing Title: LANDSCAPING SHEET 08 OF 13						
Drawing Number	Project	Originator	Volume	Location	Type	Role
RCP4	RCP4	ROD	ELS	4B_AE	DR	CH
Number	403108					
Scale (A1)	1:250	Date:	MARCH 22	Job No:	18.152	Rev:
						P02

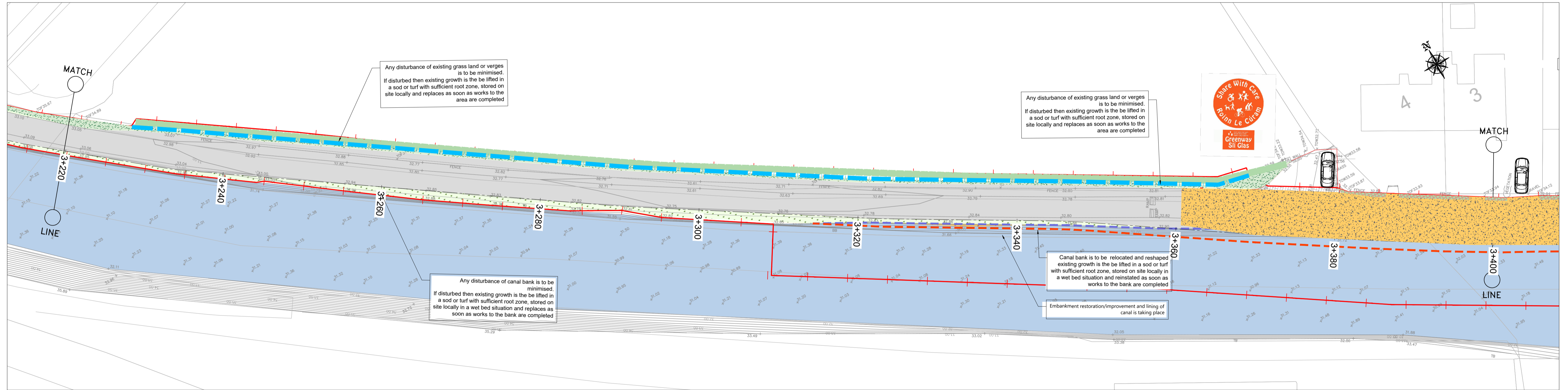
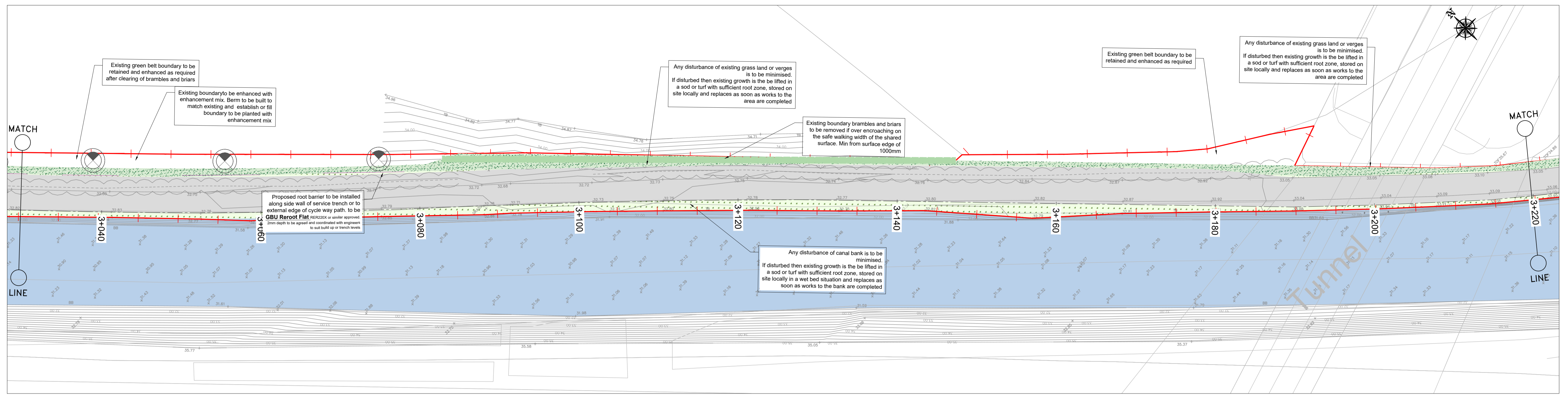

LEGEND:

- PROPOSED GREENWAY
- PROPOSED BUFF AREA
- ROYAL CANAL CHANNEL
- AREA PROVIDED BY THE EMPLOYER
- PROPOSED RETAINING WALL
- PROPOSED ROOT BARRIER
- GRASS AREA
- PLANTING HEDGE
- TREES TO BE RETAINED
- PROPOSED TREES
- TREES TO BE REMOVED



No.	Revision	Date	By	Chkd	App'd
P02	ISSUE	13.06.2023	GBR	EOC	EOC

AECOM - Roughan & O'Donovan Alliance

ROD
ROUGHAN & O'DONOVAN

AECOM

ROUGHAN & O'DONOVAN CONSULTING ENGINEERS
ARENA HOUSE, ARENA ROAD,
SANDYFORD, DUBLIN 18
D18 V8P6, IRELAND

Drawn: AG | Designed: EOC | Checked: EOC | Approved: SMG | Status: S2 - Planning

Project Title: Royal Canal Greenway Cycle And Pedestrian Route Phase 4 Phibsborough to Ashtown - Amending Part VIII						
Drawing Title: LANDSCAPING SHEET 09 OF 13						
Drawing Number	Project	Originator	Volume	Location	Type	Role
RCP4	RCP4	ROD	ELS	4B_AE	DR	CH
Number	403109					
Scale (A1)	1:250	Date:	MARCH 22	Job No:	18.152	Rev:
						P02

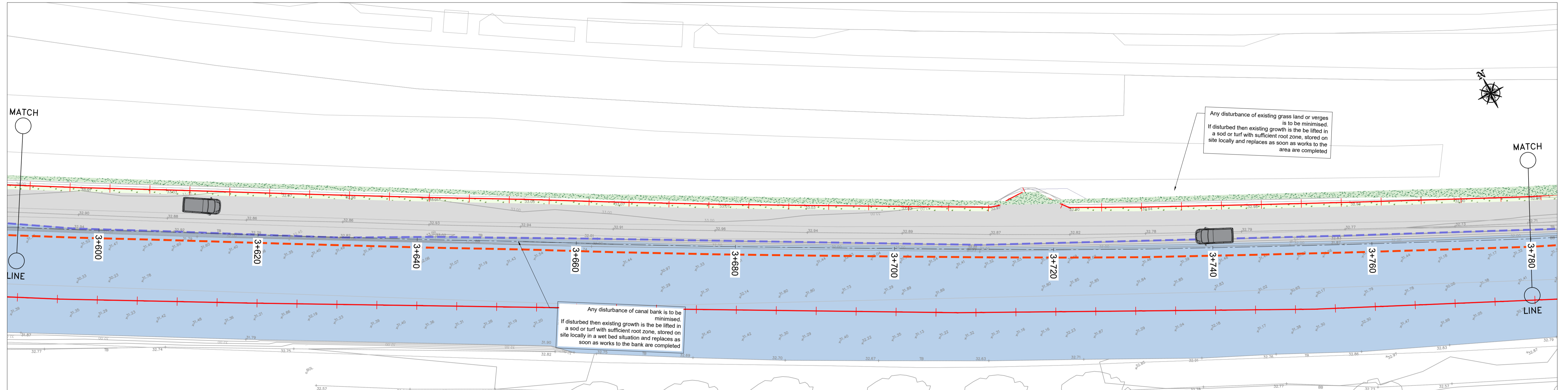
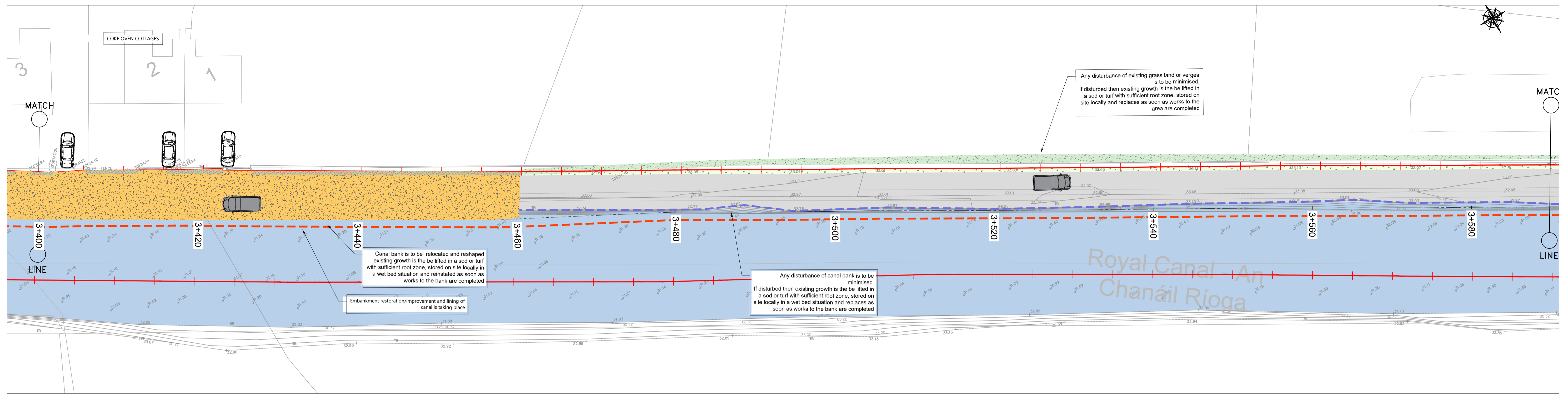

LEGEND:

- PROPOSED GREENWAY
- PROPOSED BUFF AREA
- ROYAL CANAL CHANNEL
- AREA PROVIDED BY THE EMPLOYER
- PROPOSED RETAINING WALL
- PROPOSED ROOT BARRIER
- GRASS AREA
- PLANTING HEDGE
- TREES TO BE RETAINED
- PROPOSED TREES
- TREES TO BE REMOVED



No.	Revision	Date	By	Chkd	App'd
P02	ISSUE	13.06.2023	GBR	EOC	EOC

AECOM - Roughan & O'Donovan Alliance

ROD
ROUGHAN & O'DONOVAN

AECOM

ROUGHAN & O'DONOVAN CONSULTING ENGINEERS
ARENA HOUSE, ARENA ROAD,
SANDYFORD, DUBLIN 18
D18 V8P6, IRELAND

Drawn: AG | Designed: EOC | Checked: EOC | Approved: SMG | Status: S2 - Planning

Project Title: Royal Canal Greenway Cycle And Pedestrian Route Phase 4 Phibsborough to Ashtown - Amending Part VIII						
Drawing Title: LANDSCAPING SHEET 10 OF 13						
Project	Originator	Volume	Location	Type	Role	Number
RCP4	ROD	ELS	4B_AE	DR	CH	403110
Scale (A1)	1:250	Date:	MARCH 22	Job No:	18.152	Rev:
						P02

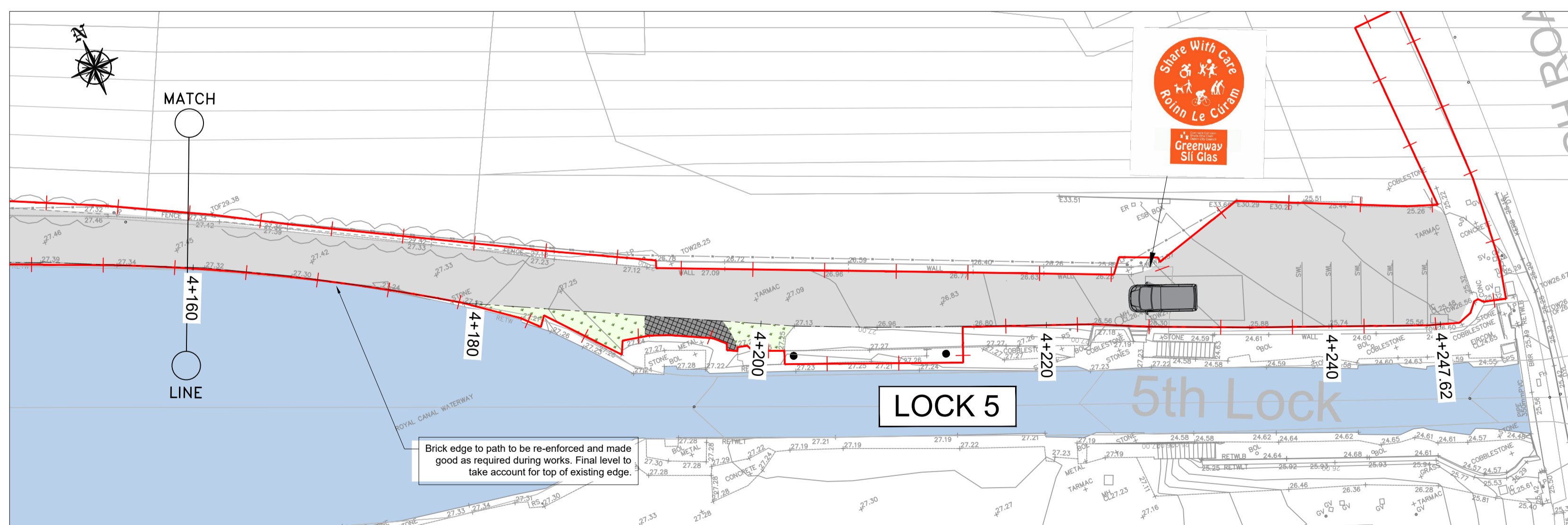
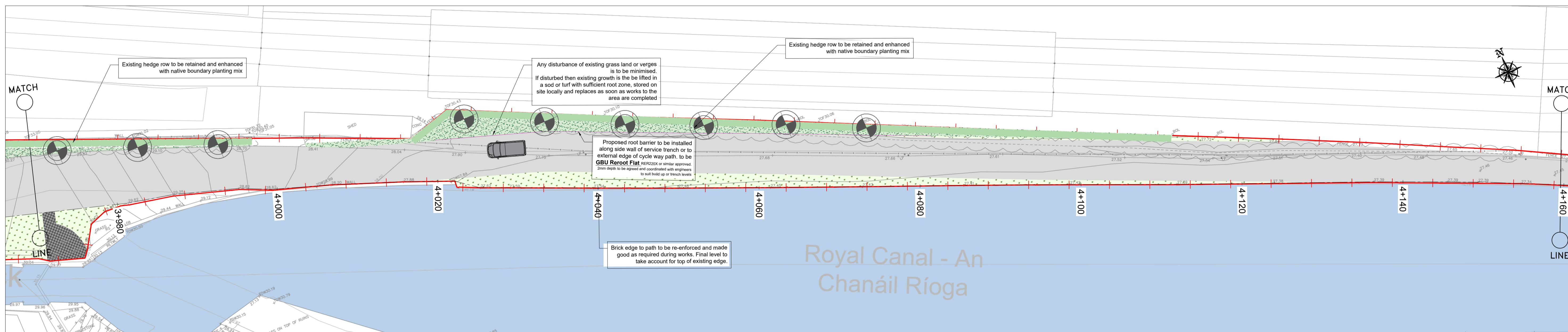
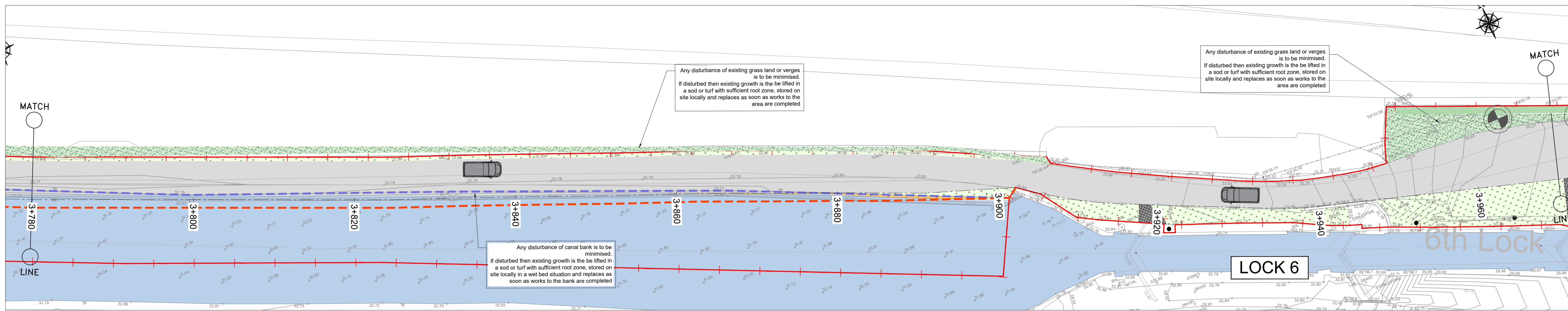

LEGEND:

- PROPOSED GREENWAY
- PROPOSED BUFF AREA
- ROYAL CANAL CHANNEL
- AREA PROVIDED BY THE EMPLOYER
- PROPOSED RETAINING WALL
- PROPOSED ROOT BARRIER
- GRASS AREA
- PLANTING HEDGE
- TREES TO BE RETAINED
- PROPOSED TREES
- TREES TO BE REMOVED

 Tionscadal Éireann Project Ireland 2040	 Comhairle Cathrach Bhaile Átha Cliath Dublin City Council	 NTA Údarás Náisiúnta Iompair National Transport Authority	<table border="1"> <tr><th>No.</th><th>Revision</th><th>Date</th><th>By</th><th>Chkd</th><th>App'd</th></tr> <tr><td>P02</td><td>ISSUE</td><td>13.06.2023</td><td>GBR</td><td>EOC</td><td>EOC</td></tr> </table>	No.	Revision	Date	By	Chkd	App'd	P02	ISSUE	13.06.2023	GBR	EOC	EOC	AECOM - Roughan & O'Donovan Alliance ROUGHAN & O'DONOVAN CONSULTING ENGINEERS ARENA HOUSE, ARENA ROAD, SANDYFORD, DUBLIN 18 D18 V8P6, IRELAND	Project Title: Royal Canal Greenway Cycle And Pedestrian Route Phase 4 Phibsborough to Ashtown - Amending Part VIII Drawing Title: LANDSCAPING SHEET 11 OF 13 <table border="1" style="font-size: small;"> <tr><th>Drawing Number</th><th>Project</th><th>Originator</th><th>Volume</th><th>Location</th><th>Type</th><th>Role</th><th>Number</th></tr> <tr><td>RCP4</td><td>RCP4</td><td>ROD</td><td>ELS</td><td>4B_AE</td><td>DR</td><td>CH</td><td>403111</td></tr> </table>	Drawing Number	Project	Originator	Volume	Location	Type	Role	Number	RCP4	RCP4	ROD	ELS	4B_AE	DR	CH	403111
No.	Revision	Date	By	Chkd	App'd																												
P02	ISSUE	13.06.2023	GBR	EOC	EOC																												
Drawing Number	Project	Originator	Volume	Location	Type	Role	Number																										
RCP4	RCP4	ROD	ELS	4B_AE	DR	CH	403111																										
Drawn: AG Designed: EOC Checked: EOC Approved: SMG Status: S2 - Planning			Scale (A1): 1:250 Date: MARCH 22 Job No: 18.152 Rev: P02																														

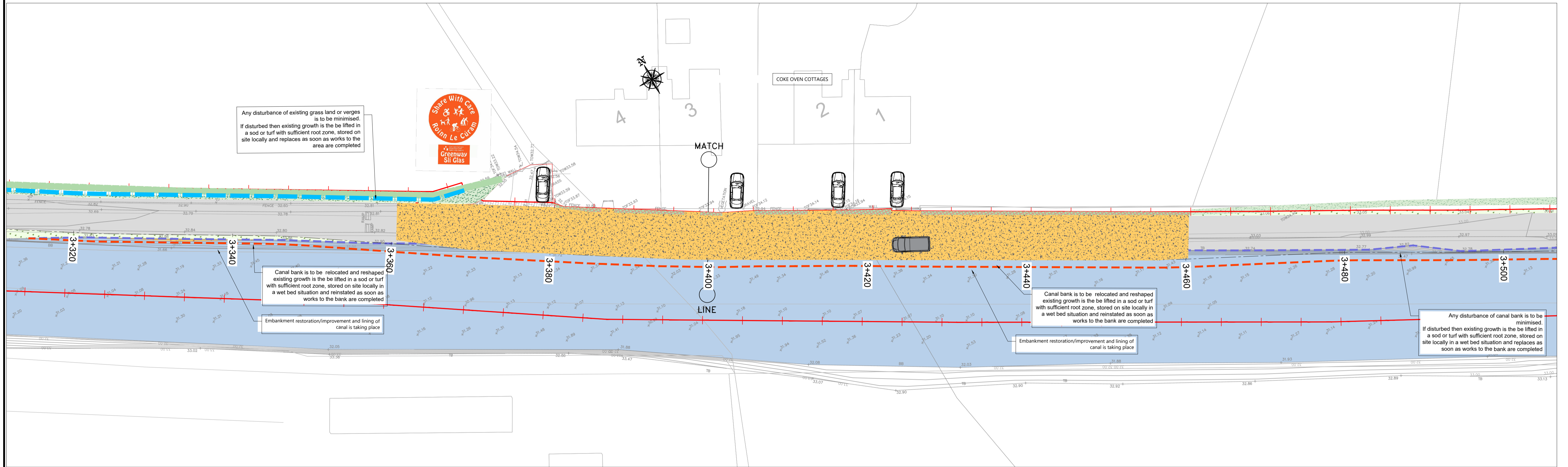

COKE COTTAGES LANDSCAPE

- WIDEN SHARED SURFACE TO ACCOMMODATE INCREASED USE
- NARROW CANAL TO ALLOW FOR WIDENING OF SHARED SURFACE
- CHANGE OF MATERIAL TO BUFF MACADAM TO CREATE A SENSE OF CHANGE TO THE FRONT OF THE COTTAGES

Indicative section of proposed cycle way to front of Cottages showing passing vehicles and passing service van and cyclist
Scale 1:50

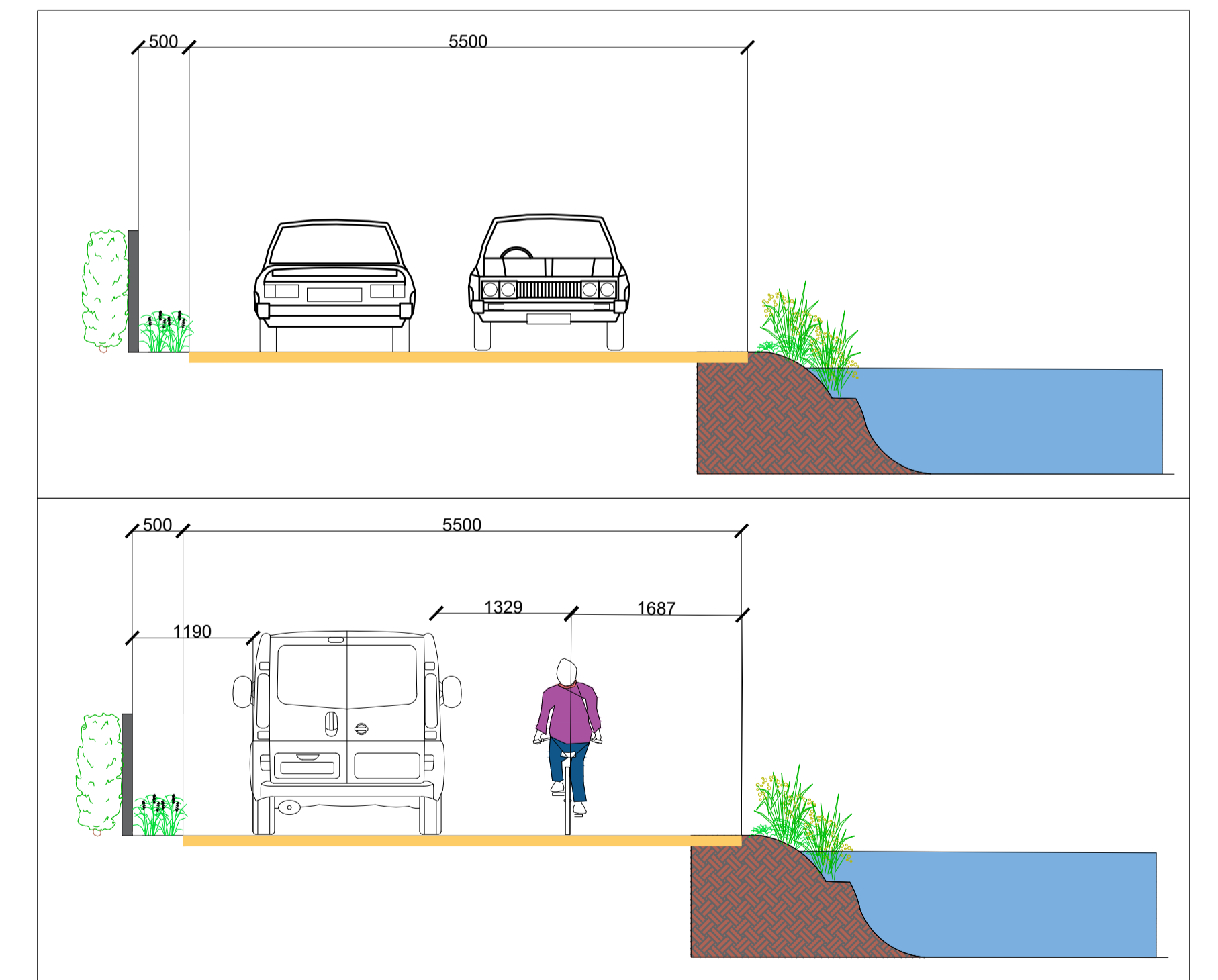

Indigenous marginal planting to enhance re-established canal bank



Sweet reed grass and Reed canary grass planted to provide movement to the planting on the re-established canal bank



Hard material selection to promote a change in the space, introducing granite sets will mark the change in function from shared surface to private access. Repeating this on the canal bank provides a notion of extra space for the cottages on the canal bank



No.	Revision	Date	By	Chk'd	App'd
P02	ISSUE	13.06.2023	GBR	EOC	EOC

AECOM - Roughan & O'Donovan Alliance



ROUGHAN & O'DONOVAN CONSULTING ENGINEERS
ARENA HOUSE, ARENA ROAD,
SANDYFORD, DUBLIN 18
D18 V8P6, IRELAND

Project Title: Royal Canal Greenway Cycle And Pedestrian Route Phase 4 Phibsborough to Ashtown - Amending Part VIII

Drawing Title: LANDSCAPING SHEET 12 OF 13

Project Number	Originator	Volume	Location	Type	Role	Number
RCP4	ROD	ELS	4B_AE	DR	CH	403112

Drawn: AG | Designed: EOC | Checked: EOC | Approved: SMG | Status: S2 - Planning

Scale (A1): AS SHOWN | Date: MARCH 22 | Job No: 18.152 | Rev: P02

TREE PROTECTION NOTES

- Prior to the commencement of any work, or any materials being brought on site, existing trees to be retained are to be protected from damage by a 2.0m high weld mesh/heras fence or similar approved. This shall be maintained in good and effective condition until the work is completed. Allow for stabiliser struts to secure fence for duration of construction.
- The protective fencing is to coincide, as far as is practical, with the root protection area (rpa), unless otherwise agreed. All weather notices shall be securely fixed to the fence words such as 'construction exclusion zone - no access'.
- The following measures are particularly important:
 - materials are never to be stacked within the root spread of the tree;
 - no oil, tar, bitumen, cement or other material is to be allowed to contaminate the ground;
 - no fires shall be lit beneath or in close proximity to the tree canopy;
 - trees to be retained should not be used as anchorages for equipment or for removing stumps, roots or other trees, or for other purposes;
 - no notices, telephone cables or other services should be attached to any part of the tree;
 - cement mixing should not be carried out within the canopy/protected area of the tree;
 - soil levels are to be maintained as existing within the root spread of the tree. Any alteration to soil levels in an area up to one and a half times the diameter of the tree canopy must be agreed with the landscape architect.

TREE PROTECTION TEMPORARY FENCING CONSTRUCTION NOTES

- Mesh wire to be galvanised chain link fence, mesh to be 50mm, wire to be 3.15/2.24mm gauge or herras type fencing panels
- Scaffold posts to be machine driven to a minimum depth of 1metre, at a maximum of 4 metre centres.
- Scaffold rails to be clamped securely to posts.
- Chain link wire to be tied to posts and rails using 200mm lengths of flexible wire.
- Temporary signage regarding tree rpa protection fixed at all times to protective fencing.

GENERAL NOTES RE TREE PROTECTION FENCING

- Tree protection fencing to be erected prior to commencement of main site works.
- Fence must remain, and be maintained for duration of construction period.
- Any damage to Tree Protection Fencing to be communicated to Project Arborist immediately.
- No works to be carried out within Tree Protection Zone without prior consultation and permission of project arborist.
- Tree Protection to BS5837-2012

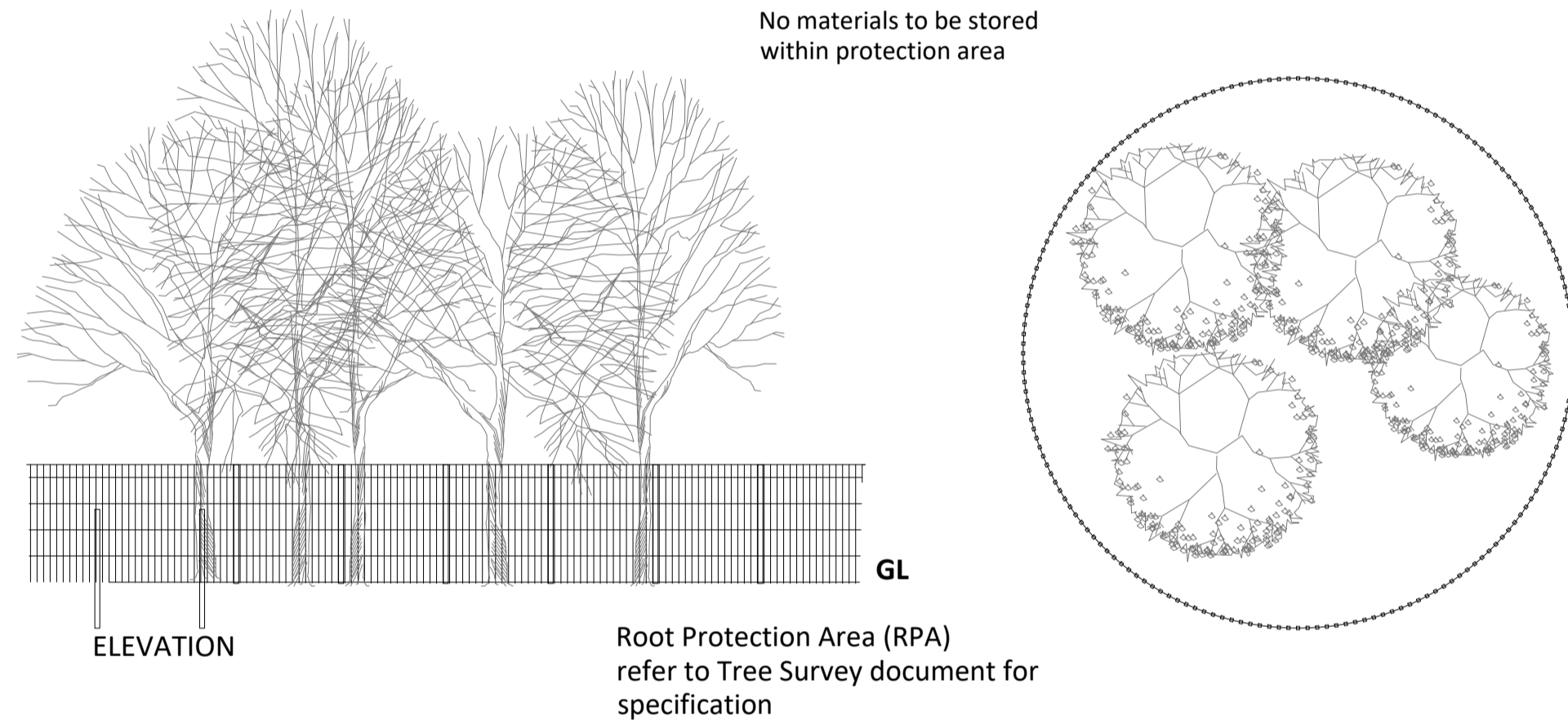

No materials to be stored within protection area

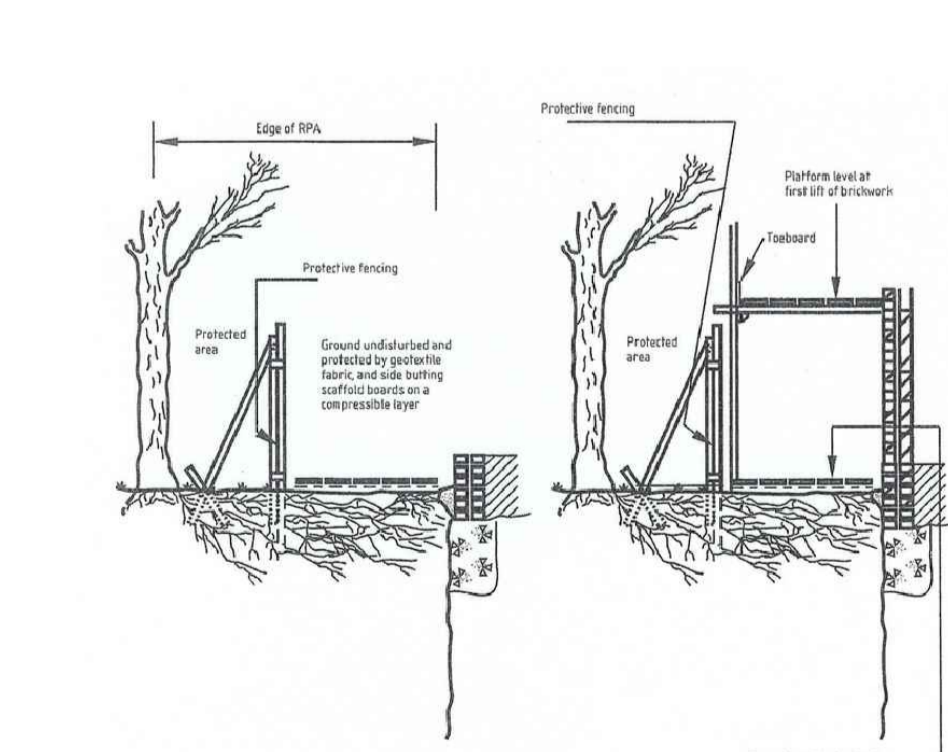

Figure 3. – Scaffolding within the RPA

Reference image



GROUND PROTECTION WITH SCAFFOLD
A scaffold framework attached to the main scaffold fencing can be used to support either scaffold planks or plywood to create an elevated platform with a gap beneath.

GENERAL NOTES RE OTHER TREE PROTECTION MEASURES

- Tree protection measures to be installed prior to commencement of main site works.
- Protection measures must remain and be maintained for duration of construction period.
- Any damage to tree protection measures to be communicated to project arborist and rectified immediately.
- No works to be carried out within tree root protection area without prior consultation and permission of project arborist.
- Tree protection to BS5837-2012

IMPORTANT NOTES RE ROOTS PROTECTION

- Excavate using specialised compressed air tools or hand tools such as forks and spades, with a preference for air tools. **Note:** Do not mechanically excavate.
- If using hand tools, avoid accidental bark damage by using a fork to loosen the soil to help locate any substantial roots.
- Use a smaller tool such as a trowel to clear the soil away from roots without damaging the bark.
- Remove soil/material from the excavation without disturbing the adjacent rooting environment.
- Retain flexible clumps of smaller fibrous roots if they can be displaced temporarily or permanently beyond the excavation without damage.
- Cut exposed roots to be removed cleanly 10–20cm behind the final face of the excavation.
- Protect roots temporarily exposed, but to be retained, from direct sunlight, drying out, and extremes of temperature, by appropriate covering such as dampened hessian sacking and/or boards over the hole.
- If necessary, individual roots and clumps of less than 2.5cm width shall be cut cleanly without consulting the supervising arboriculturist.
- Retain individual roots and clumps greater than 2.5cm in width where possible and only cut if agreed with the supervising arboriculturist.
- When back-filling, place an inert granular material mixed with top soil or sharp sand around retained roots greater than 2.5cm in width before light compaction.

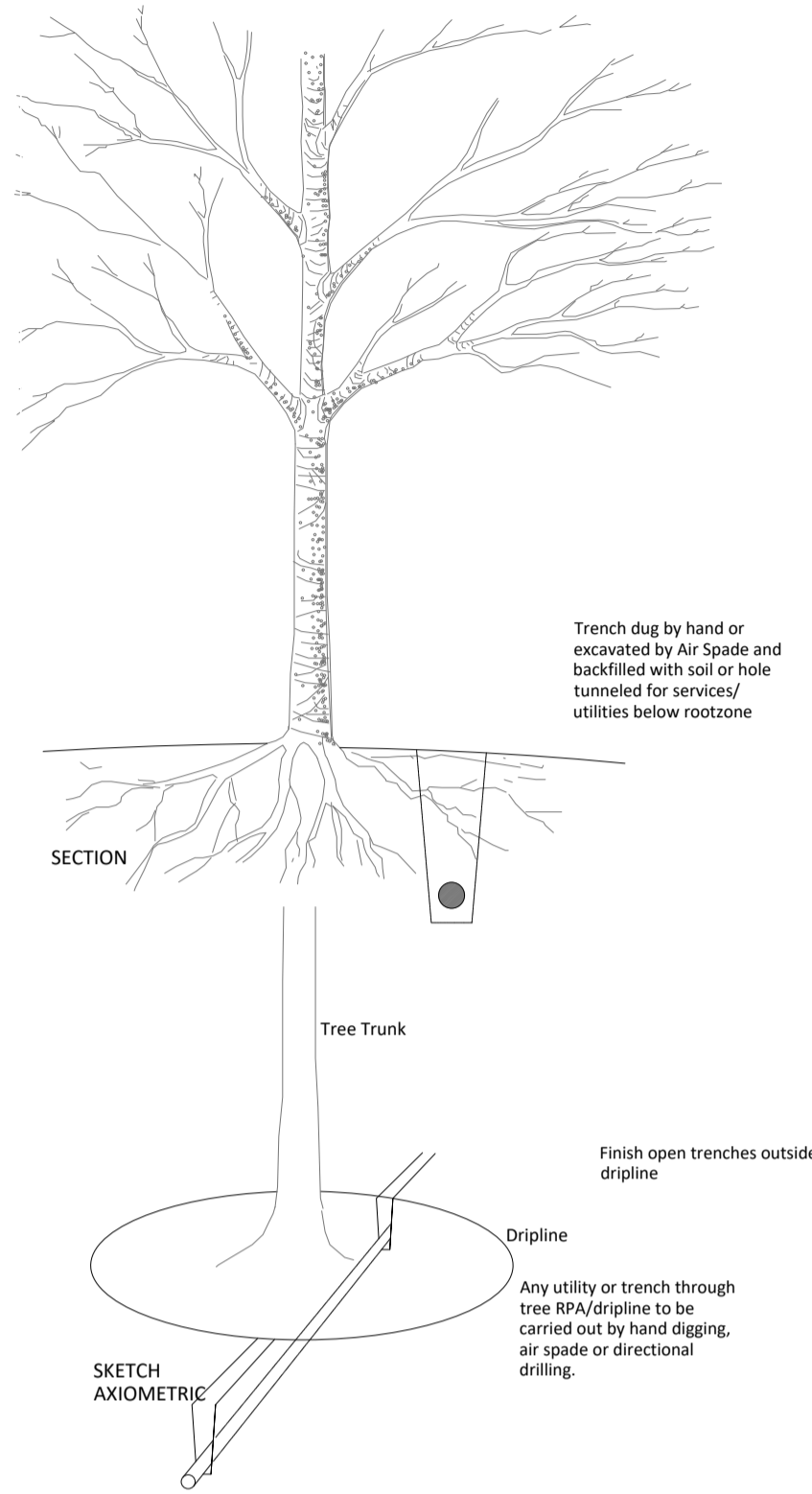

Reference images



All excavation in RPAs should be with handheld tools. Where possible, there will be a preference to use air tools because they are very effective at exposing roots and services with minimal damage. Air tools are particularly useful where roots are very dense.

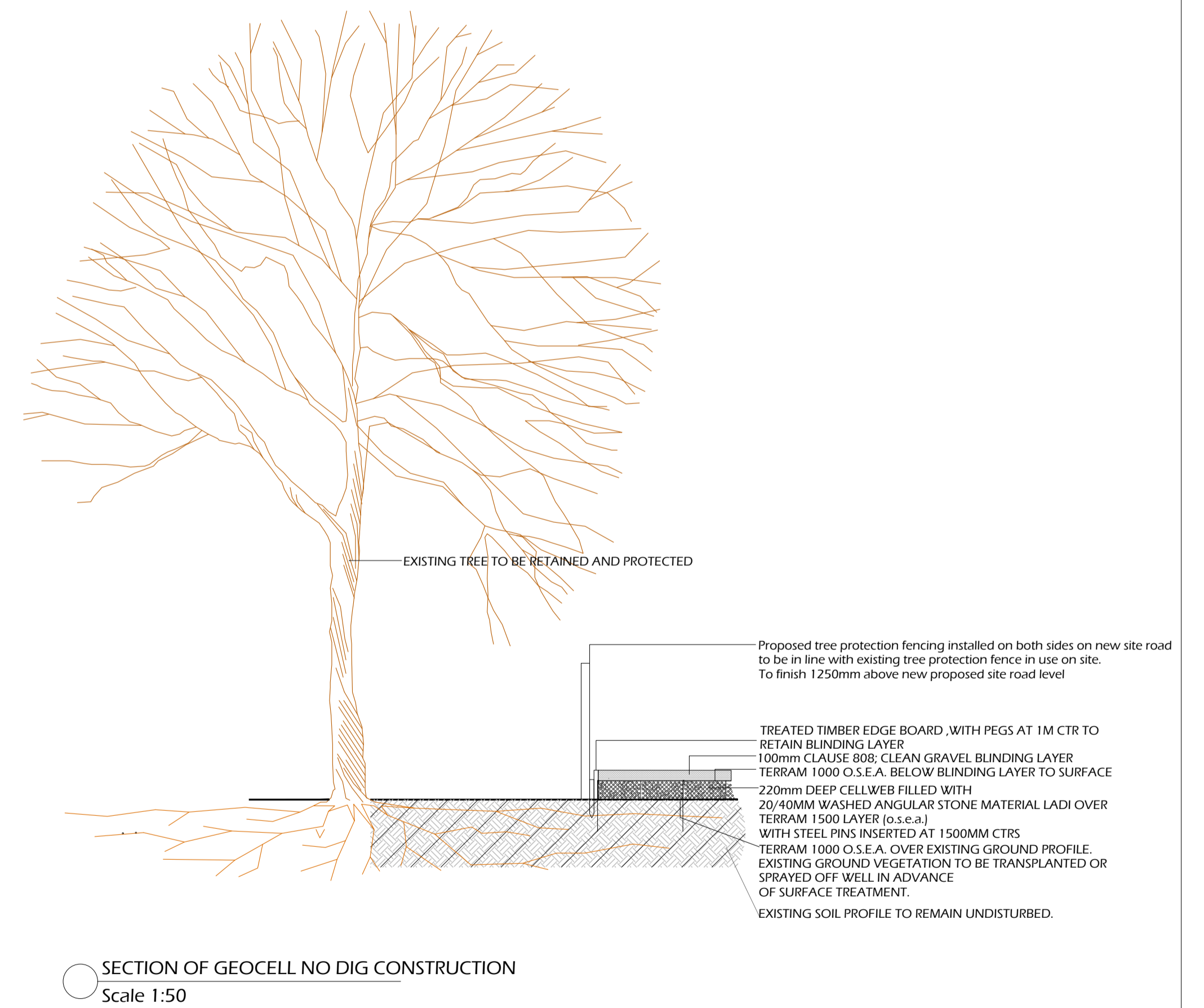

SECTION OF GEOCELL NO DIG CONSTRUCTION
Scale 1:50



No.	Revision	Date	By	Chk'd	App'd
P02	ISSUE	13.06.2023	GBR	EOC	EOC

AECOM - Roughan & O'Donovan Alliance



ROUGHAN & O' DONOVAN CONSULTING ENGINEERS
ARENA HOUSE, ARENA ROAD,
SANDYFORD, DUBLIN 18
D18 V8P6, IRELAND

Project Title: Royal Canal Greenway Cycle And Pedestrian Route Phase 4 Phibsborough to Ashtown - Amending Part VIII

Drawing Title: LANDSCAPING SHEET 13 OF 13

Project	Originator	Volume	Location	Type	Role	Number
RCP4	ROD	ELS	4B_AE	DR	CH	403113

Drawn: AG | Designed: EOC | Checked: EOC | Approved: SMG | Status: S2 - Planning

Scale (A1): AS SHOWN | Date: MARCH 22 | Job No: 18.152 | Rev: P02