**Comhairle Cathrach
Bhaile Átha Cliath
Dublin City Council**

ROINN COMHSHAOIL AGUS IOMPAIR
 RANNAN DEARADH AGUS TOGÁIL BÓITHRE
 Oifigi na Cathrach, An Ché Adhmaid, Baile Átha Cliath, D08 RF3F

ENVIRONMENT AND TRANSPORTATION DEPARTMENT
 ROAD DESIGN & CONSTRUCTION DIVISION
 Civic Offices, Wood Quay, Dublin, D08 RF3F

Dr. John W. Flanagan, C.Eng. F.I.E.L. F.I.C.E.
 Assistant Chief Executive and City Engineer

Title:
**AUTOTURN 3_RH TURN
DUKE LN LWR TO DUKE LN UPPR**

Scales: NTS Date: Nov. '22

Original Drawing Size: 297 x 420 - A3

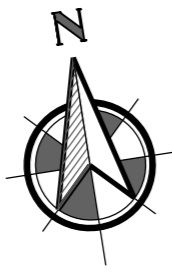

Marks and Spencer
loading/service
entrance

Rear of
First Tech
Credit Union
Dawson House



REFUSE 3 AXLE
 Marks and Spencer
 Width 2.50
 Track 2.50
 Lock to Lock Time 6.0
 Steering Angle 35.3

DUKE LANE LOWER

The DUKE
Gilligans

- Bollard
- Bollard
- Retractable Bollard
- Retractable Bollard
- Bollard
- Bollard
- Bollard

DUKE LANE UPPER

Duchess

Vacant

Vacant

Duke St.
Gallery

Car Park
Entrance

Oscar

Ladbrokes

Vacant

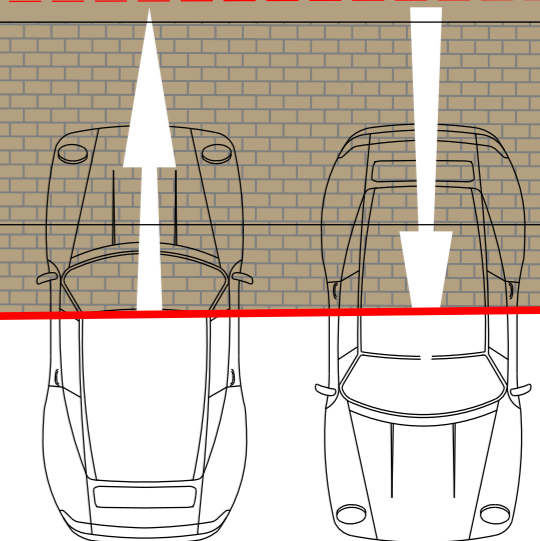

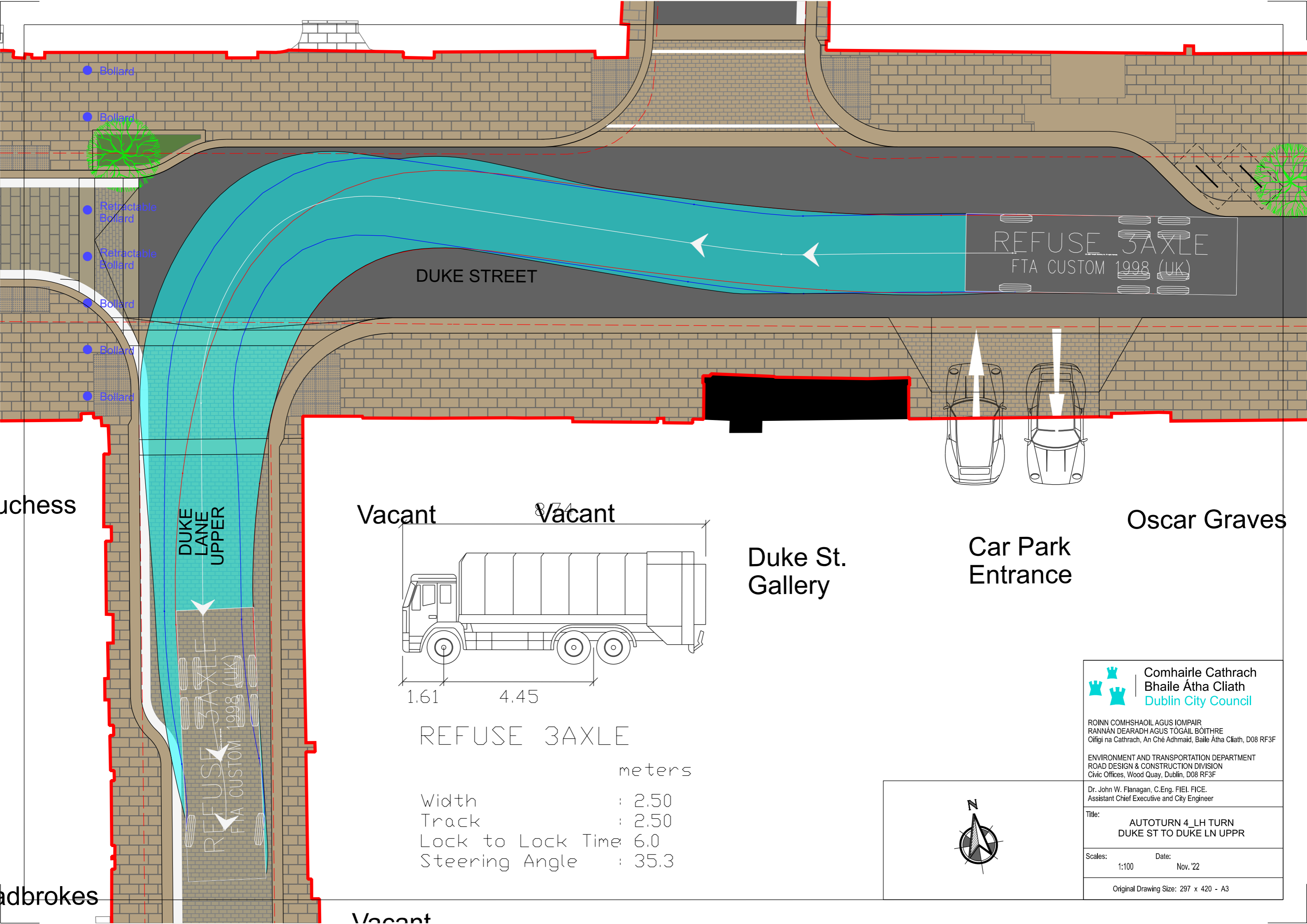

Bollard

Bollard

Retractable Bollard

Retractable Bollard

Bollard

Bollard

Bollard

uchess

DUKE LANE UPPER

DUKE STREET

REFUSE 3AXLE
FTA CUSTOM 1998 (UK)

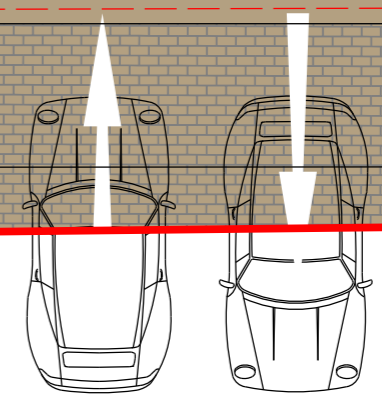

Oscar Graves

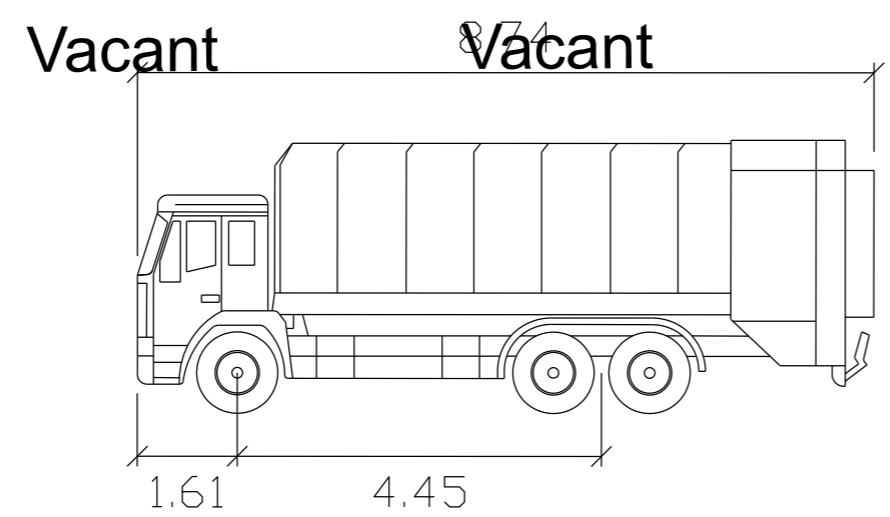

Duke St. Gallery

Car Park Entrance

REFUSE 3AXLE

meters

- Width : 2.50
- Track : 2.50
- Lock to Lock Time : 6.0
- Steering Angle : 35.3

adbrokes

Vacant

Comhairle Cathrach
Bhaile Átha Cliath
Dublin City Council

ROINN COMHSHAOIL AGUS IOMPAIR
RANNÁN DEARADH AGUS TÓGÁIL BÓITHRE
Oifigi na Cathrach, An Ché Adhmaid, Baile Átha Cliath, D08 RF3F

ENVIRONMENT AND TRANSPORTATION DEPARTMENT
ROAD DESIGN & CONSTRUCTION DIVISION
Civic Offices, Wood Quay, Dublin, D08 RF3F

Dr. John W. Flanagan, C.Eng. F.I.E.L. F.I.C.E.
Assistant Chief Executive and City Engineer

Title:
AUTOTURN 4_LH TURN
DUKE ST TO DUKE LN UPPR

Scales: 1:100 Date: Nov. '22

Original Drawing Size: 297 x 420 - A3



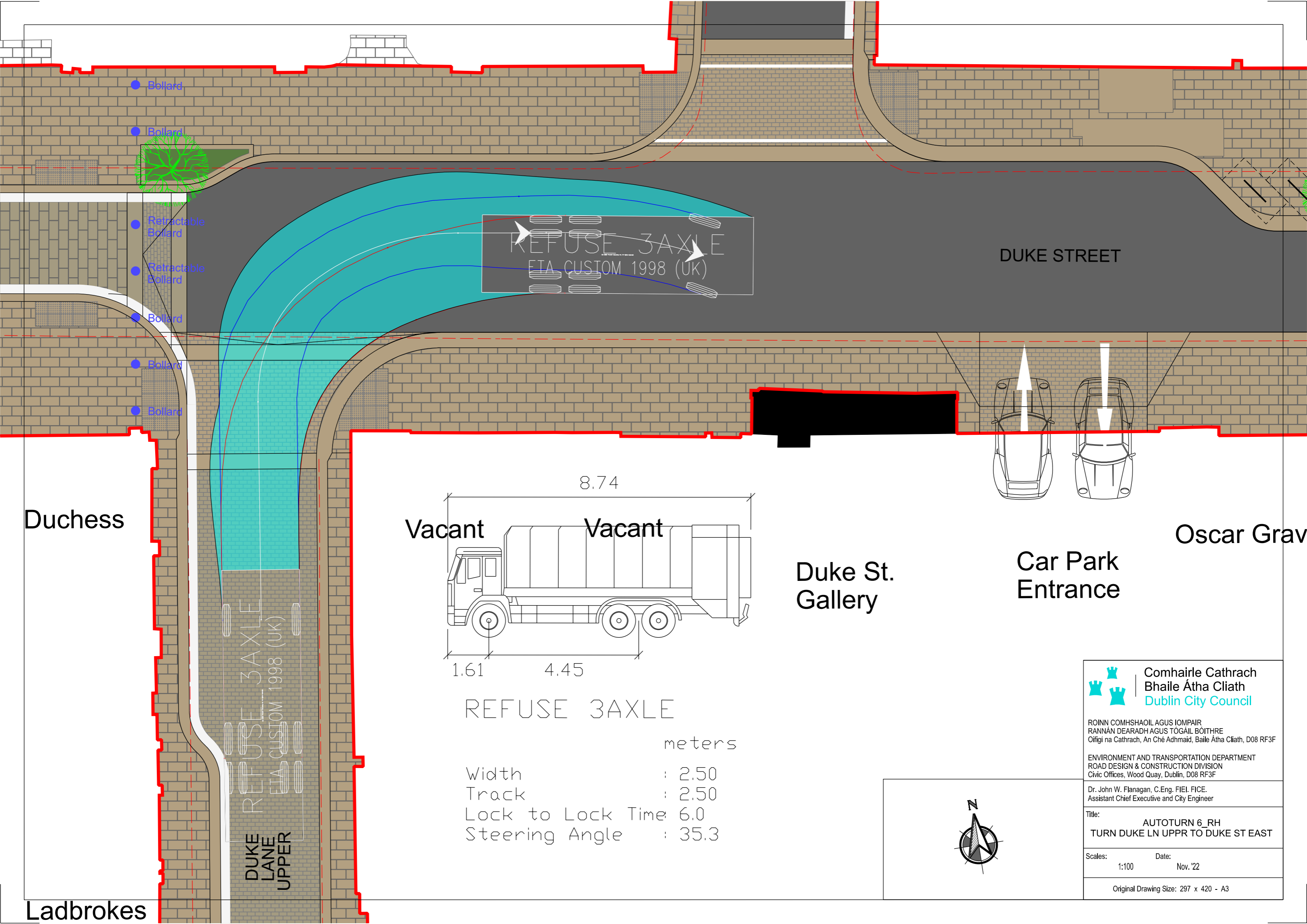

Bollard

Bollard

Retractable Bollard

Retractable Bollard

Bollard

Bollard

Bollard

DUKE STREET

Duchess

Ladbrokes

REFUSE 3AXLE
ETA CUSTOM 1998 (UK)
DUKE LANE
UPPER

REFUSE 3AXLE
ETA CUSTOM 1998 (UK)

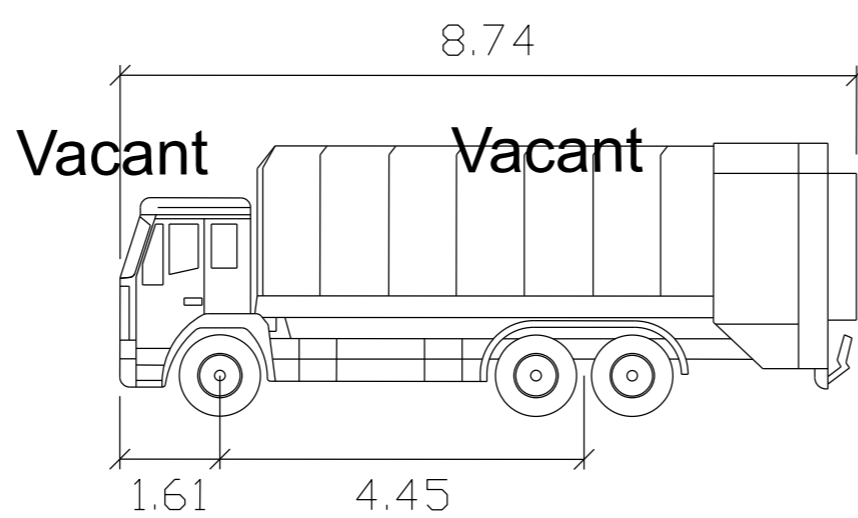

REFUSE 3AXLE meters

Width	: 2.50
Track	: 2.50
Lock to Lock Time	: 6.0
Steering Angle	: 35.3

Duke St.
Gallery

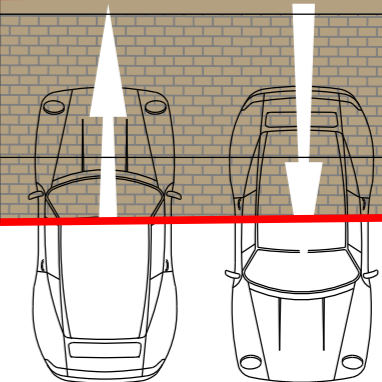

Car Park
Entrance

Oscar Grav

Comhairle Cathrach Bhaile Átha Cliath
Dublin City Council

ROINN COMHSHAOIL AGUS IOMPAIR
RANNÁN DEARADH AGUS TÓGÁIL BÓITHRE
Oifigi na Cathrach, An Ché Adhmaid, Baile Átha Cliath, D08 RF3F

ENVIRONMENT AND TRANSPORTATION DEPARTMENT
ROAD DESIGN & CONSTRUCTION DIVISION
Civic Offices, Wood Quay, Dublin, D08 RF3F

Dr. John W. Flanagan, C.Eng. F.I.E.L. F.I.C.E.
Assistant Chief Executive and City Engineer

Title: AUTOTURN 6_RH
TURN DUKE LN UPPR TO DUKE ST EAST

Scales: 1:100 Date: Nov. '22

Original Drawing Size: 297 x 420 - A3



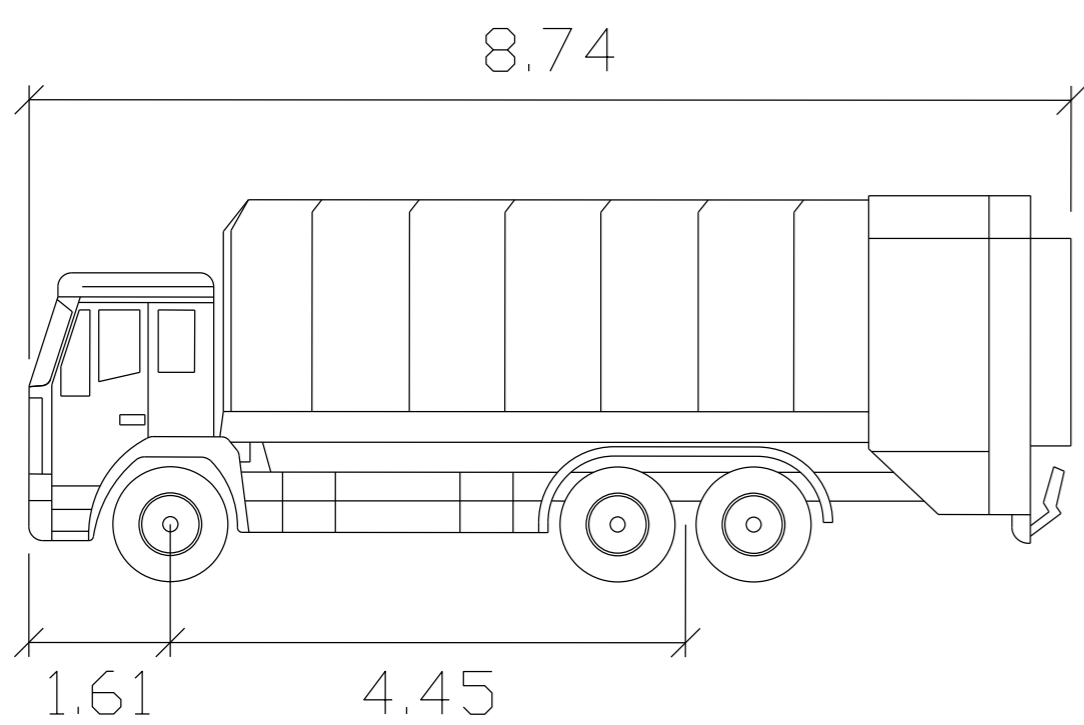

REFUSE 3AXLE

meters

- Width : 2.50
- Track : 2.50
- Lock to Lock Time : 6.0
- Steering Angle : 35.3

The Gotham Cafe

John Kehoe

Doctor 1816 Aesthetics

Vacant

Sheridan's Cheese Mongers

Isabelle's

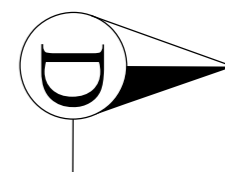

Bollard

Bollard

Retractable Bollard

Retractable Bollard

Bollard

Bollard

Bollard

Retractable Bollard

Retractable Bollard

Retractable Bollard

ANNE STREET SOUTH

Smile's Orthodontics

Trinity Clinic

Italian Heel Bar

Links London (Vacant)

Aviary Lane Hairdresser

Magee

Number Twenty Two

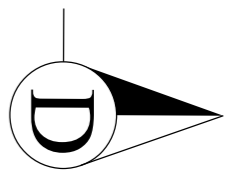

Comhairle Cathrach
Bhaile Átha Cliath
Dublin City Council

ROINN COMHSHAOL AGUS IOMPAIR
RANNAN DEARADH AGUS TOGAIL BÓITHRE
Oifigi na Cathrach, An Ché Adhmaid, Baile Átha Cliath, D08 RF3F

ENVIRONMENT AND TRANSPORTATION DEPARTMENT
ROAD DESIGN & CONSTRUCTION DIVISION
Civic Offices, Wood Quay, Dublin, D08 RF3F

Dr. John W. Flanagan, C.Eng, F.I.E., F.I.C.E.,
Assistant Chief Executive and City Engineer

Title:
AUTOTURN 7_DUKE L'N UPPR ACROSS
STH ANNE ST AND INTO ANNE'S LN_NTS

Scales: NTS Date: Nov, '22

Original Drawing Size: 297 x 420 - A3

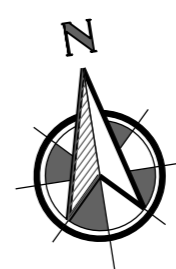

Brown Thomas
Buvina and Marketing

Doctor 1816
Aesthetics



ROINN COMHSHAOL AGUS IOMPAIR
RANNAN DEARADH AGUS TOGÁIL BÓITHRE
Oifigi na Cathrach, An Ché Adhmaid, Baile Átha Cliath, D08 RF3F

ENVIRONMENT AND TRANSPORTATION DEPARTMENT
ROAD DESIGN & CONSTRUCTION DIVISION
Civic Offices, Wood Quay, Dublin, D08 RF3F

Dr. John W. Flanagan, C.Eng, F.I.E.L, F.I.C.E.
Assistant Chief Executive and City Engineer

Title:
AUTOTURN 8. ANNE'S LN ACROSS STH
ANNE ST AND INTO DUKE LN UPPR_NTS

Scales: NTS Date: Nov '22

Original Drawing Size: 297 x 420 - A3

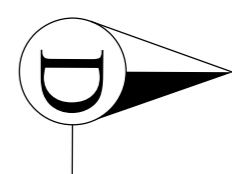
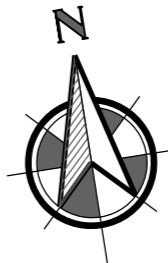

The Gotham
Cafe

John Kehoe

Vacant

Sheridan's
Cheese
Mongers

Isabelle's

Bollard

Bollard

Retractable
Bollard

Retractable
Bollard

Bollard

Bollard

Bollard

Retractable
Bollard

Retractable
Bollard

Retractable
Bollard

ANNE STREET SOUTH

Smile's
Orthodontics

Trinity Clinic

Italian
Heel
Bar

ANNE'S LANE

REFUSE 3 AXLE
EIA CUSTOM 1998 (UK)

Links
London
(Vacant)

Aviary Lane
Hairdresser

Magee

Number
Twenty Two

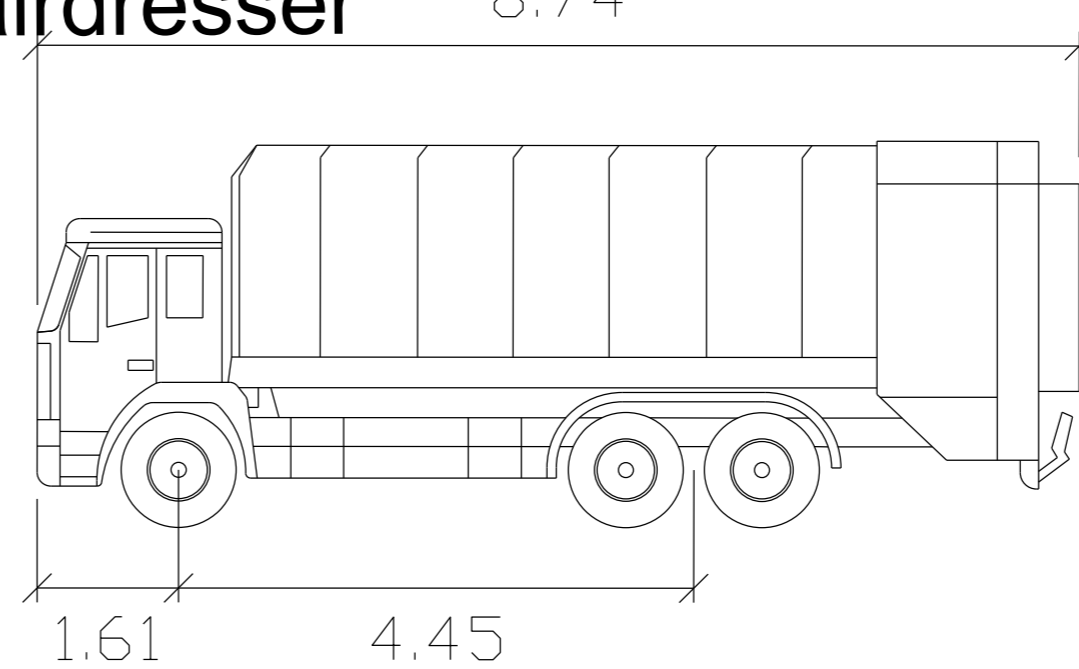

REFUSE 3 AXLE

meters

Width : 2.50
Track : 2.50
Lock to Lock Time : 6.0
Steering Angle : 35.3

Brown Thomas

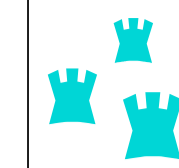
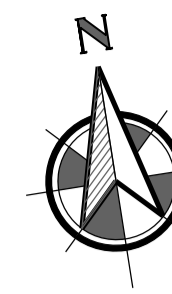

Comhairle Cathrach
Bhaile Átha Cliath
Dublin City Council

ROINN COMHSHAOL AGUS IOMPAIR
RANNÁN DEARADH AGUS TÓGÁIL BÓITHRE
Oifigi na Cathrach, An Ché Adhmaid, Baile Átha Cliath, D08 RF3F

ENVIRONMENT AND TRANSPORTATION DEPARTMENT
ROAD DESIGN & CONSTRUCTION DIVISION
Civic Offices, Wood Quay, Dublin, D08 RF3F

Dr. John W. Flanagan, C.Eng. F.I.E.I. F.I.C.E.
Assistant Chief Executive and City Engineer

Title:
AUTOTURN 10_LH TURN FROM DUKE LN
UPPR INTO STH ANNES ST EAST NTS

Scales: 1:100 Date: Nov. '22

Original Drawing Size: 297 x 420 - A3

Doctor 1816
Aesthetics

The Gotham
Cafe

John Kehoe

Vacant

Sheridan's
Cheese
Mongers

Isabelle's

ANNE STREET SOUTH

ANNE'S LANE

Smile's
Orthodontics

Aviary Lane

Magee

ber
nty Two

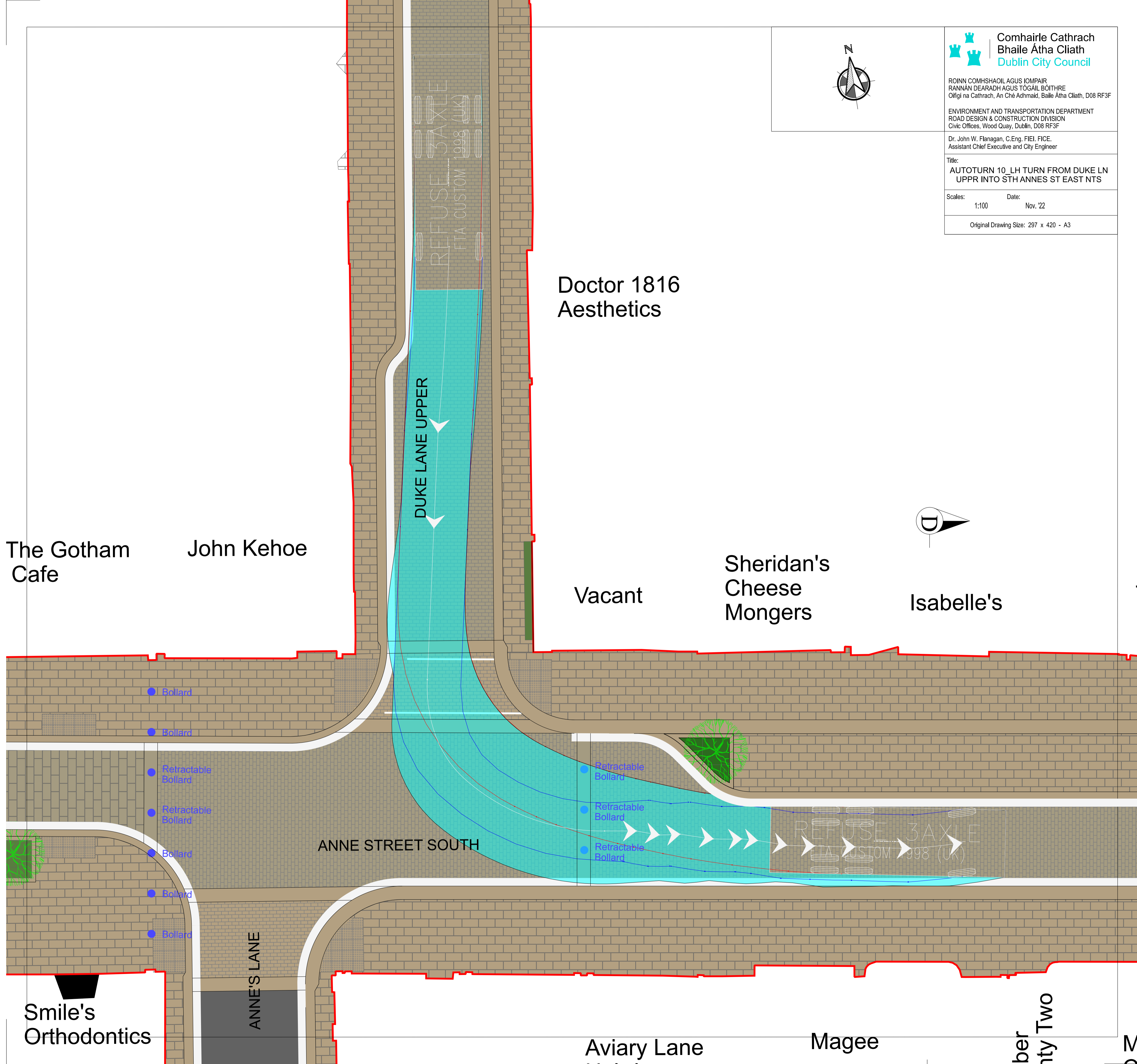



Comhairle Cathrach
Bhaile Átha Cliath
Dublin City Council

ROINN COMHSHAOIL AGUS IOMPAIR
RANNAN DEARADH AGUS TÓGÁIL BÓITHRE
Oifigi na Cathrach, An Ché Adhmaid, Baile Átha Cliath, D08 RF3F

ENVIRONMENT AND TRANSPORTATION DEPARTMENT
ROAD DESIGN & CONSTRUCTION DIVISION
Civic Offices, Wood Quay, Dublin, D08 RF3F

Dr. John W. Flanagan, C.Eng. FIEI, FICE.
Assistant Chief Executive and City Engineer

Title:
AUTOTURN 11_RH TURN FROM DUKE LN
UPPR INTO STH ANNES ST WEST

Scales: 1:100 Date: Nov. '22

Original Drawing Size: 297 x 420 - A3



Rockets

The Gotham
Cafe

John Kehoe

DUKE LANE
UPPER

Vacant

Sheridan's
Cheese
Mongers

Isabelle's

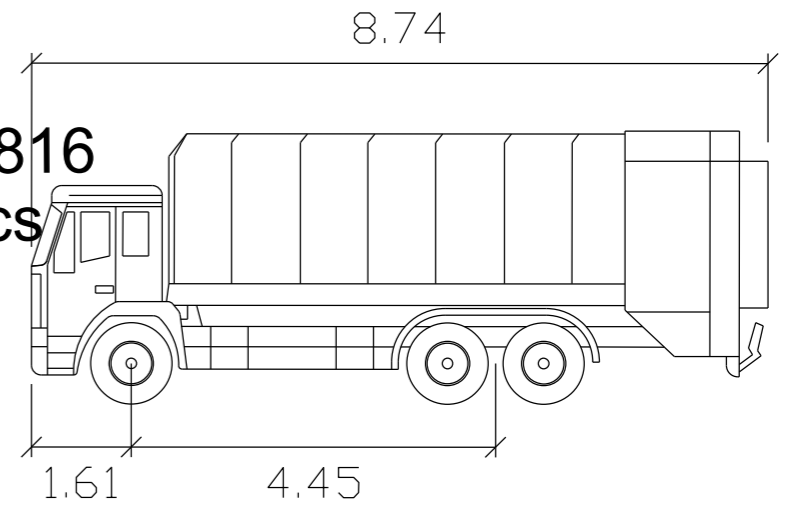

REFUSE 3AXLE

meters

Width : 2.50
Track : 2.50
Lock to Lock Time : 6.0
Steering Angle : 35.3

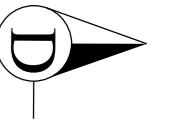

Bollard

Bollard

Retractable
Bollard

Retractable
Bollard

Bollard

Bollard

Bollard

Retractable
Bollard

Retractable
Bollard

Retractable
Bollard

ANNE STREET SOUTH

ANNE'S LANE

REFUSE 3AXLE
FTA CUSTOM 1998 (UK)

BENCH TYPE B

BENCH TYPE B

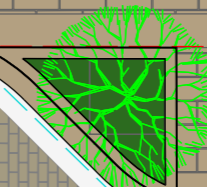
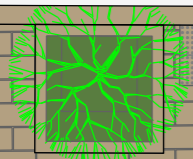

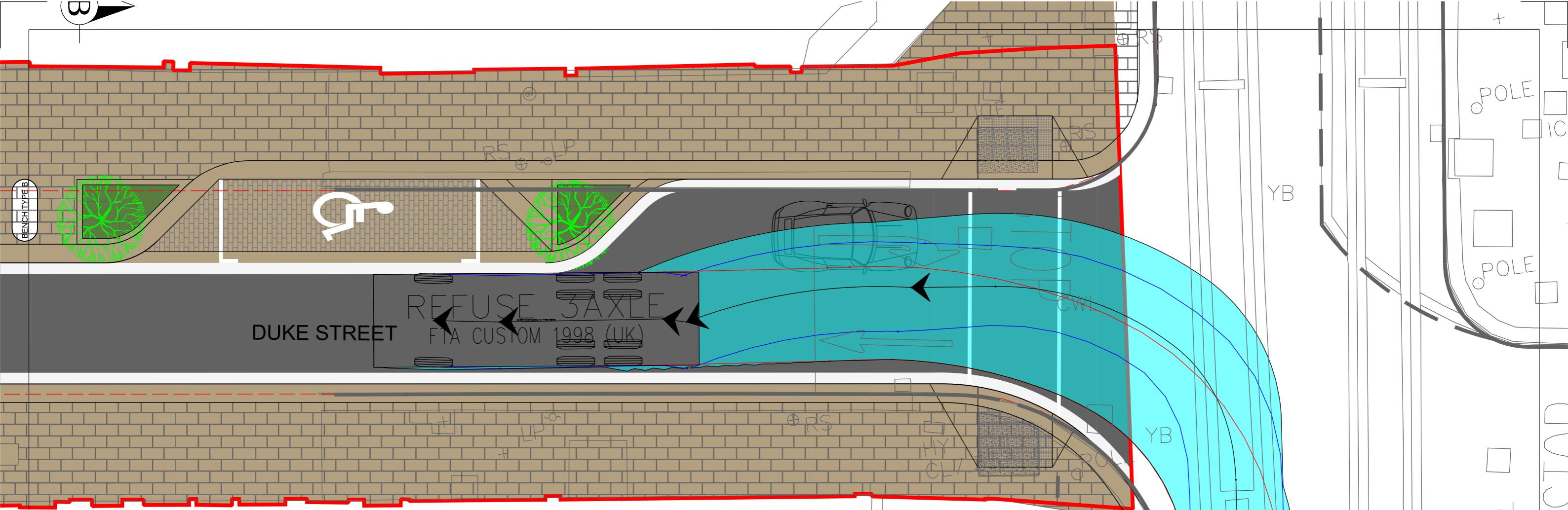

Yum Thai Noodle Bar

8.74
Butler's Chocolate Cafe

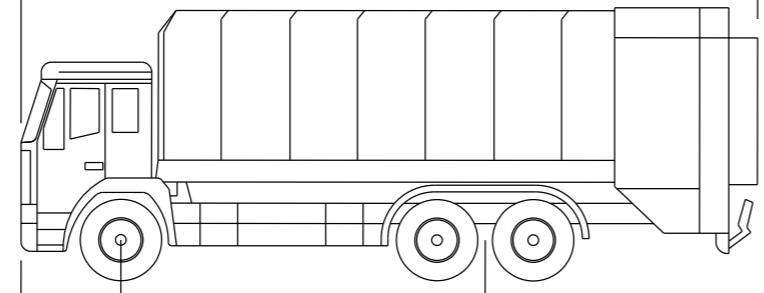

REFUSE 3AXLE

	width	: 2.50
	Track	: 2.50
	Lock to Lock Time	: 6.0
	Steering Angle	: 35.3

Comhairle Cathrach Bhaile Átha Cliath
Dublin City Council

ROINN COMHSHAOL AGUS IOMPAIR
RANNÁN DEARADH AGUS TÓGÁIL BÓITHRE
Oifigi na Cathrach, An Ché Adhmaid, Baile Átha Cliath, D08 RF3F

ENVIRONMENT AND TRANSPORTATION DEPARTMENT
ROAD DESIGN & CONSTRUCTION DIVISION
Civic Offices, Wood Quay, Dublin, D08 RF3F

Dr. John W. Flanagan, C.Eng. F.I.E. F.I.C.E.
Assistant Chief Executive and City Engineer

Title:
**AUTOTURN 15_LH TURN
DAWSON ST INTO DUKE ST**

Scales: 1:100 Date: Oct. '22

Original Drawing Size: 297 x 420 - A3

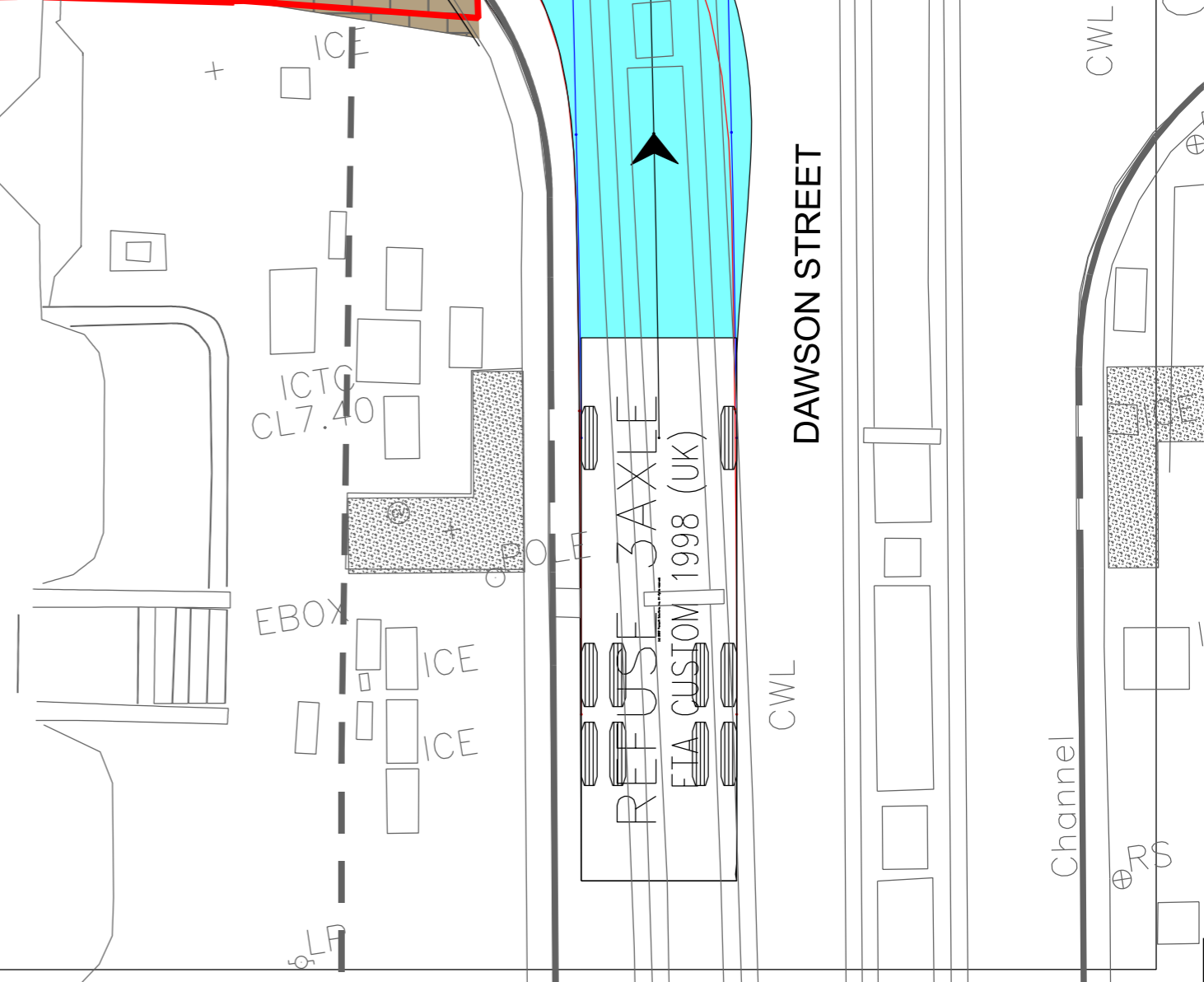

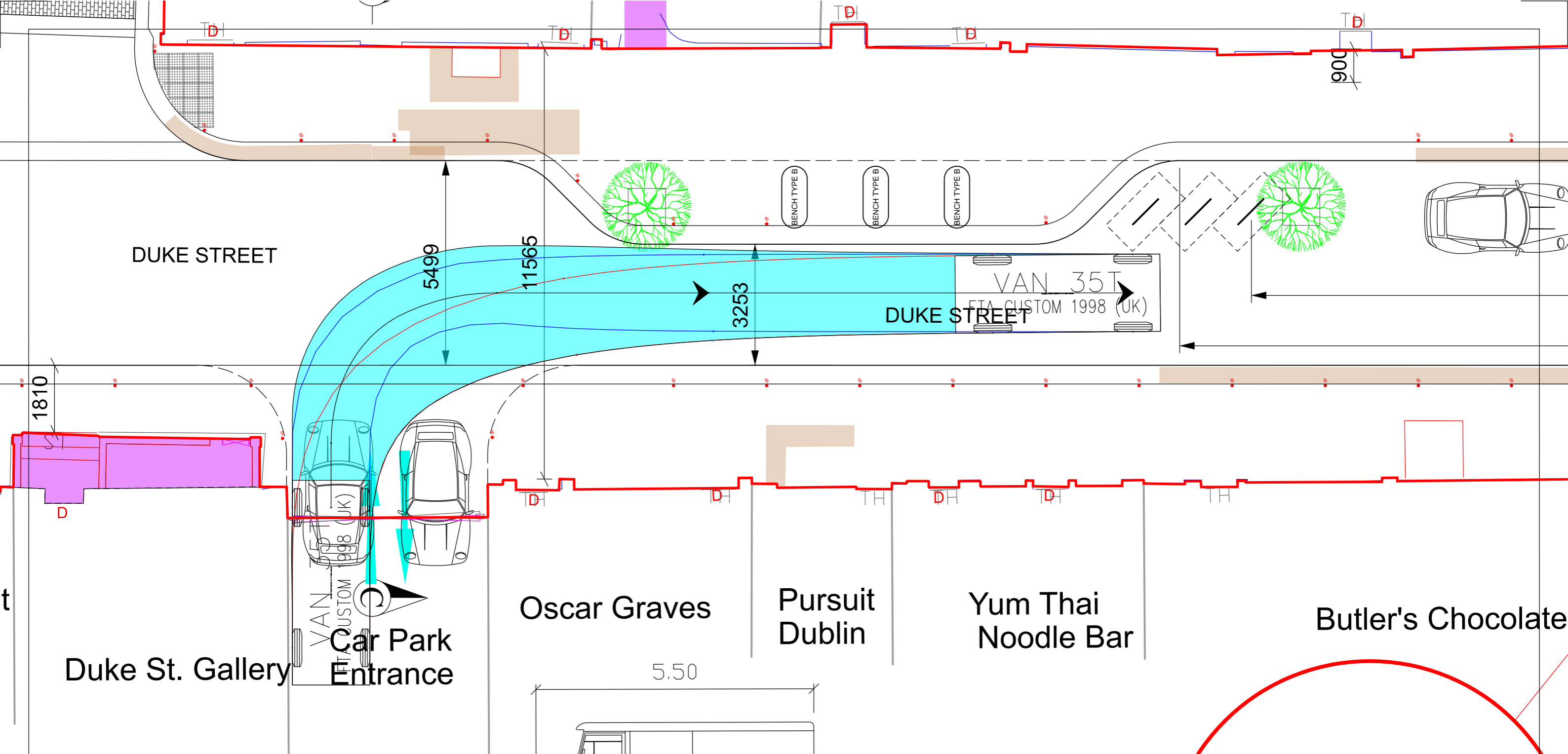

**Comhairle Cathrach
Bhaile Átha Cliath
Dublin City Council**
 ROINN COMHSHAOIL AGUS IOMPAIR
 RANNÁN DEARADH AGUS TÓGÁIL BÓITHRE
 Oifigi na Cathrach, An Ché Adhmaid, Baile Átha Cliath, D08 RF3F
 ENVIRONMENT AND TRANSPORTATION DEPARTMENT
 ROAD DESIGN & CONSTRUCTION DIVISION
 Civic Offices, Wood Quay, Dublin, D08 RF3F
 Dr. John W. Flanagan, C.Eng. F.I.E.I. F.I.C.E.
 Assistant Chief Executive and City Engineer
 Title: AUTOTURN X_DUKE ST
 CAR PARK ENTRANCE
 ONTO DUKE ST EAST_VAN
 Scales: NTS
 Original Drawing Size: 297 x 420 - A3

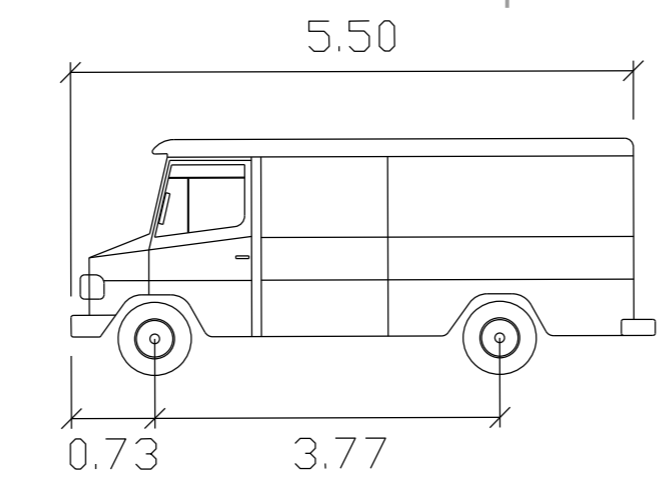

	meters
Width	: 2.08
Track	: 2.08
Lock to Lock Time	6.0
Steering Angle	: 41.5

PEDESTRIAN ZONE
 6:00 - 11:00
 Except Deliveries
 11:00 - 6:00
 Except for Access