

TYPICAL DETAIL - Permeable paving - 1/20 @A1

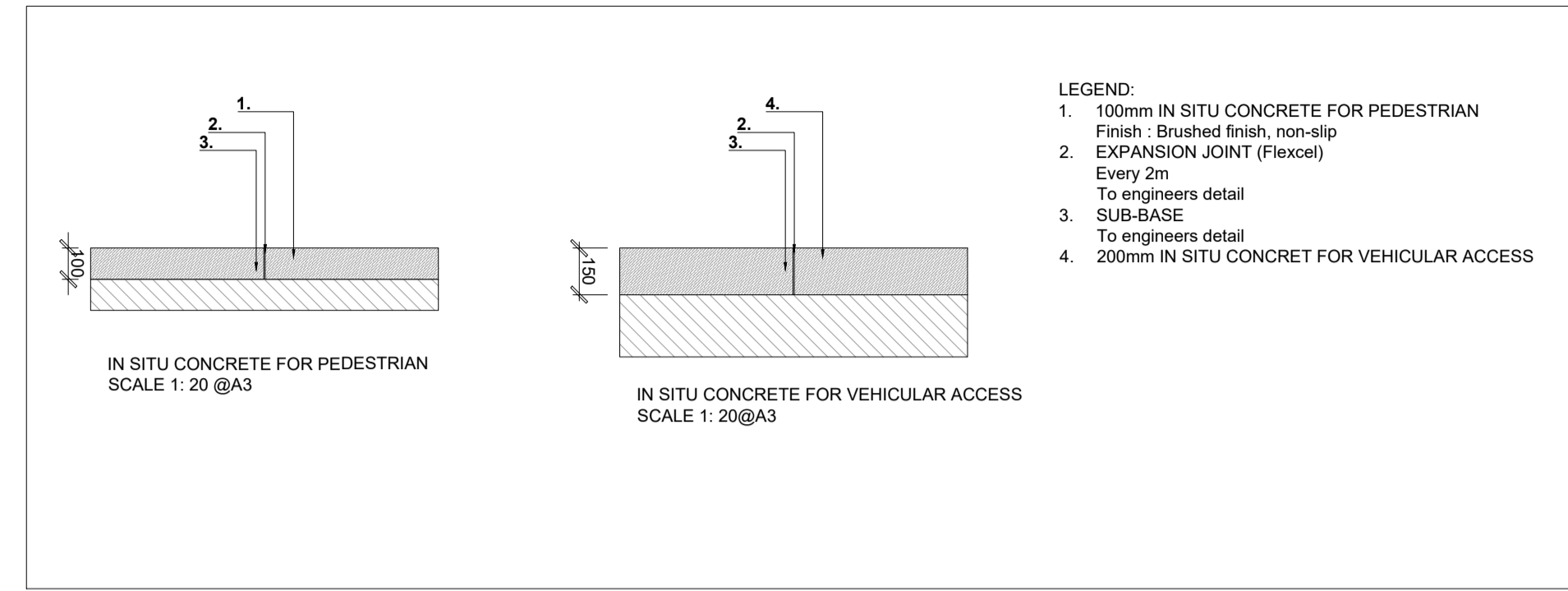

TYPICAL DETAIL - Brush concrete for footpath - 1/20 @A1

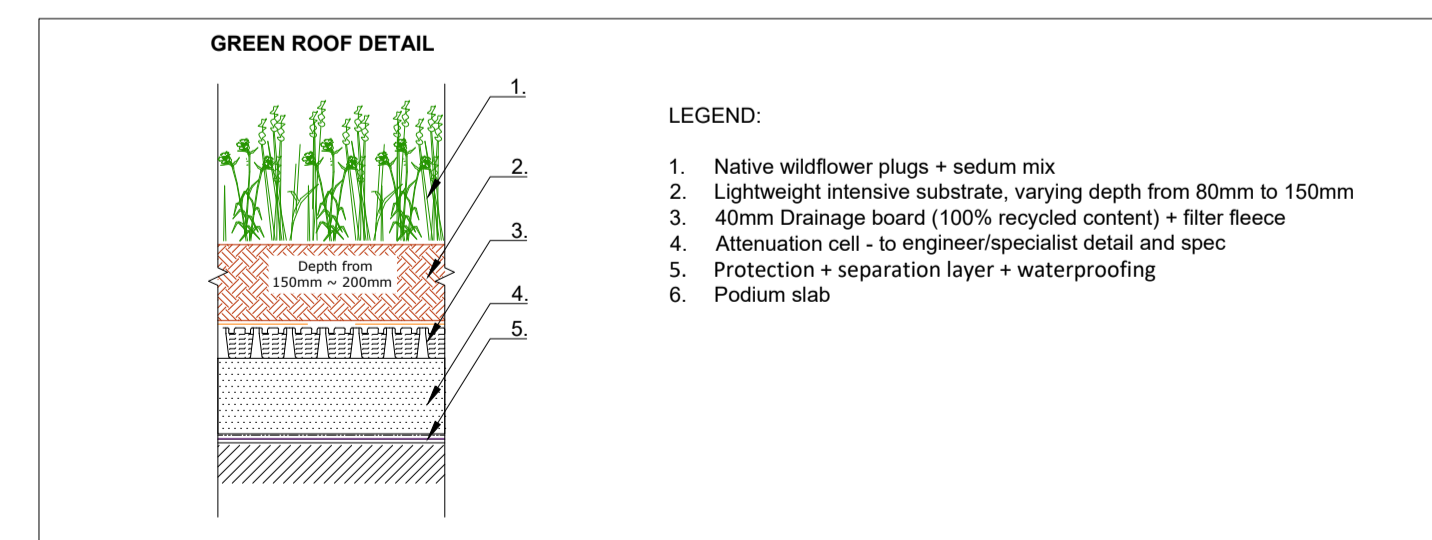
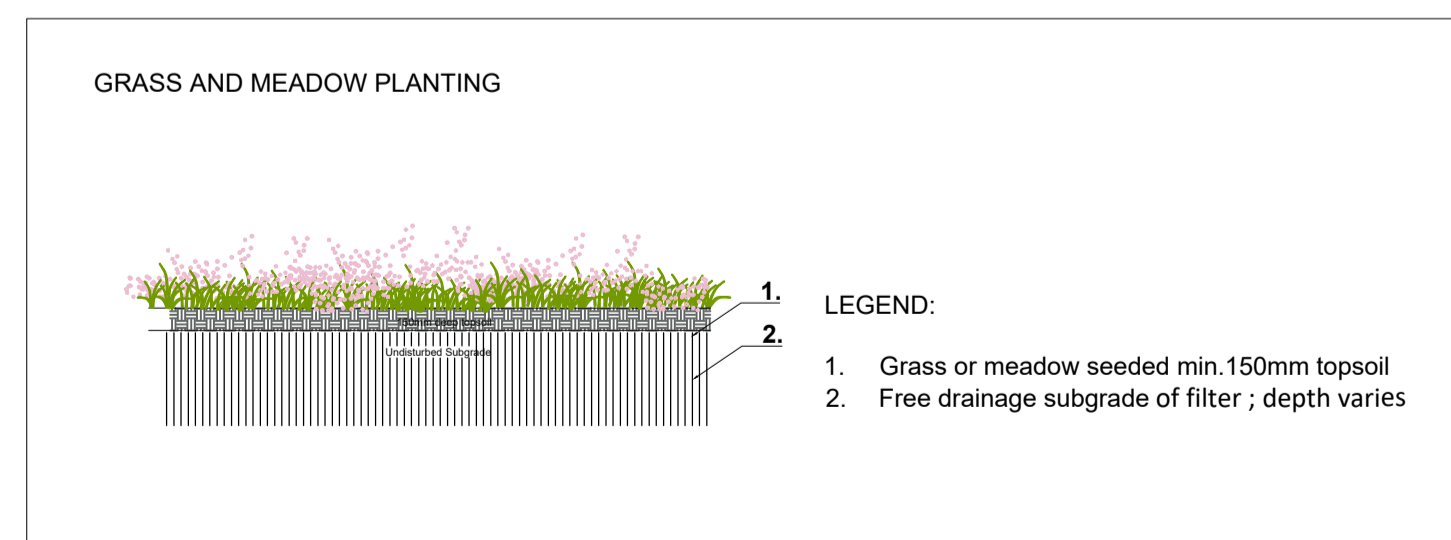
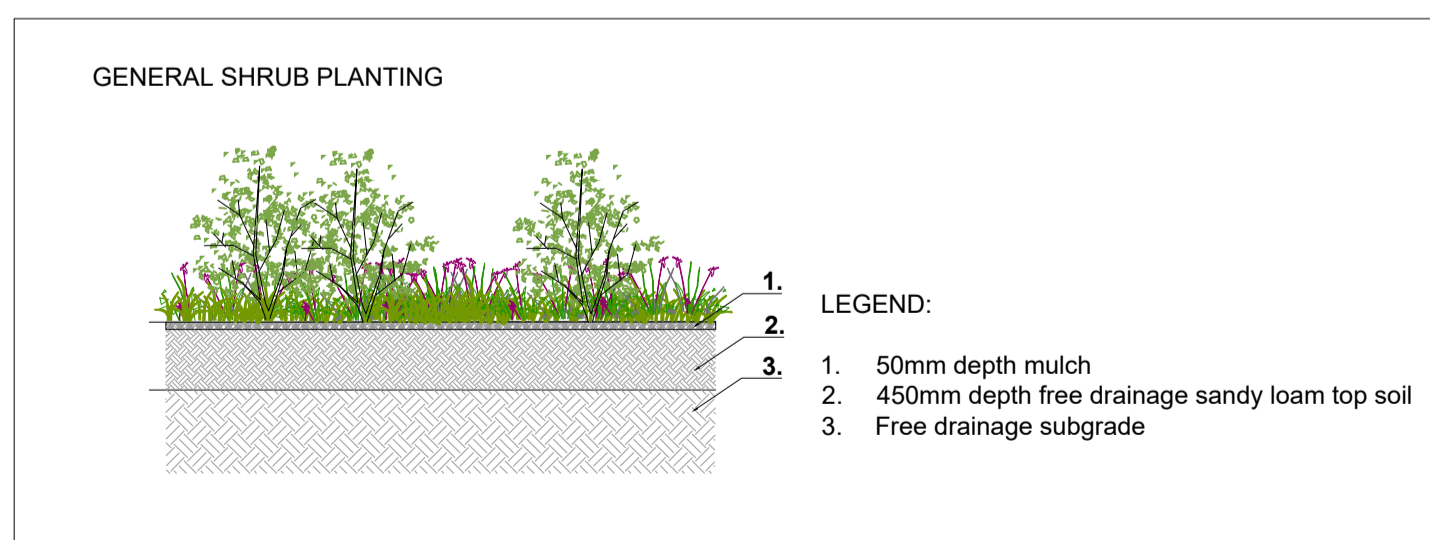
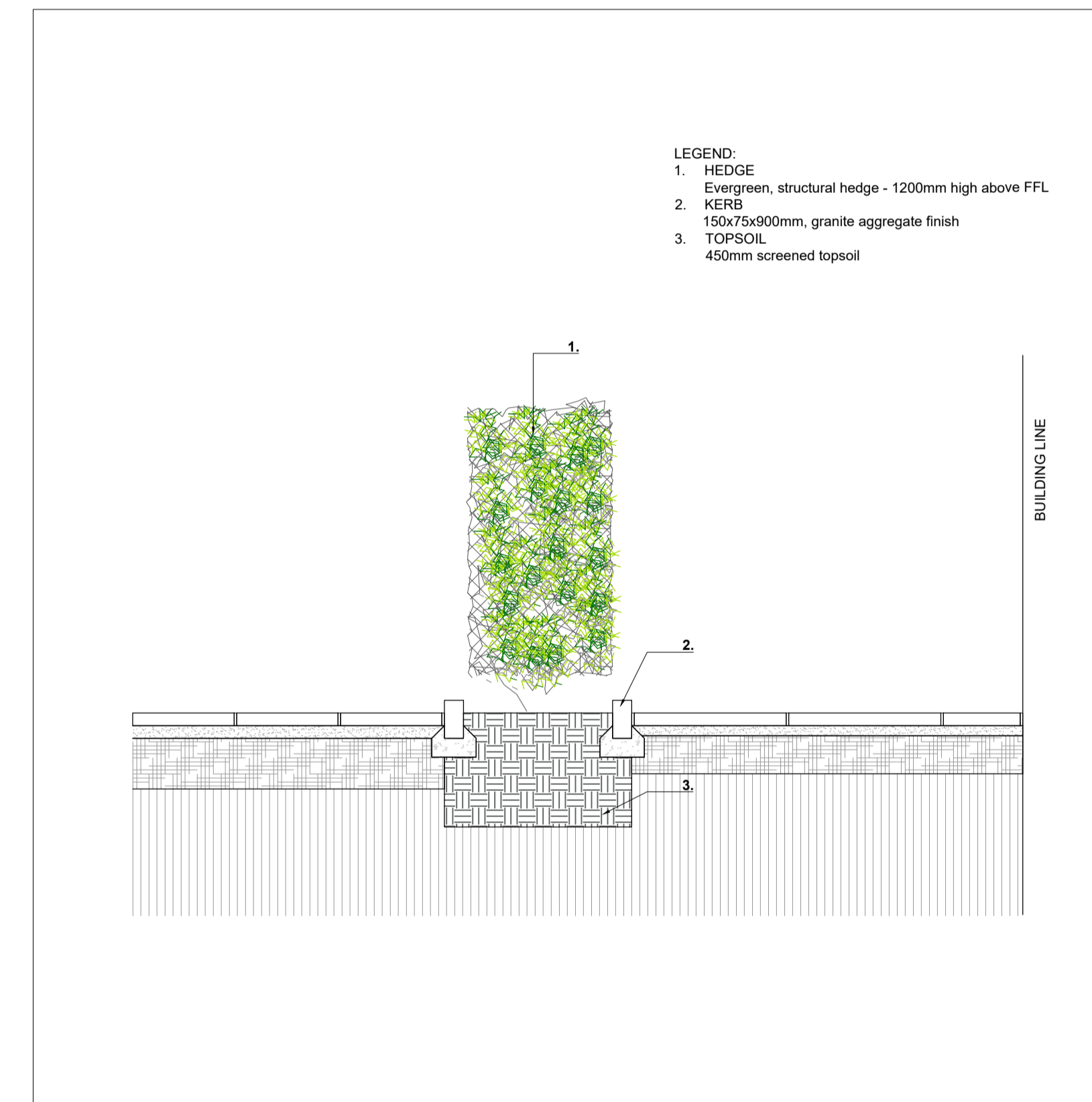
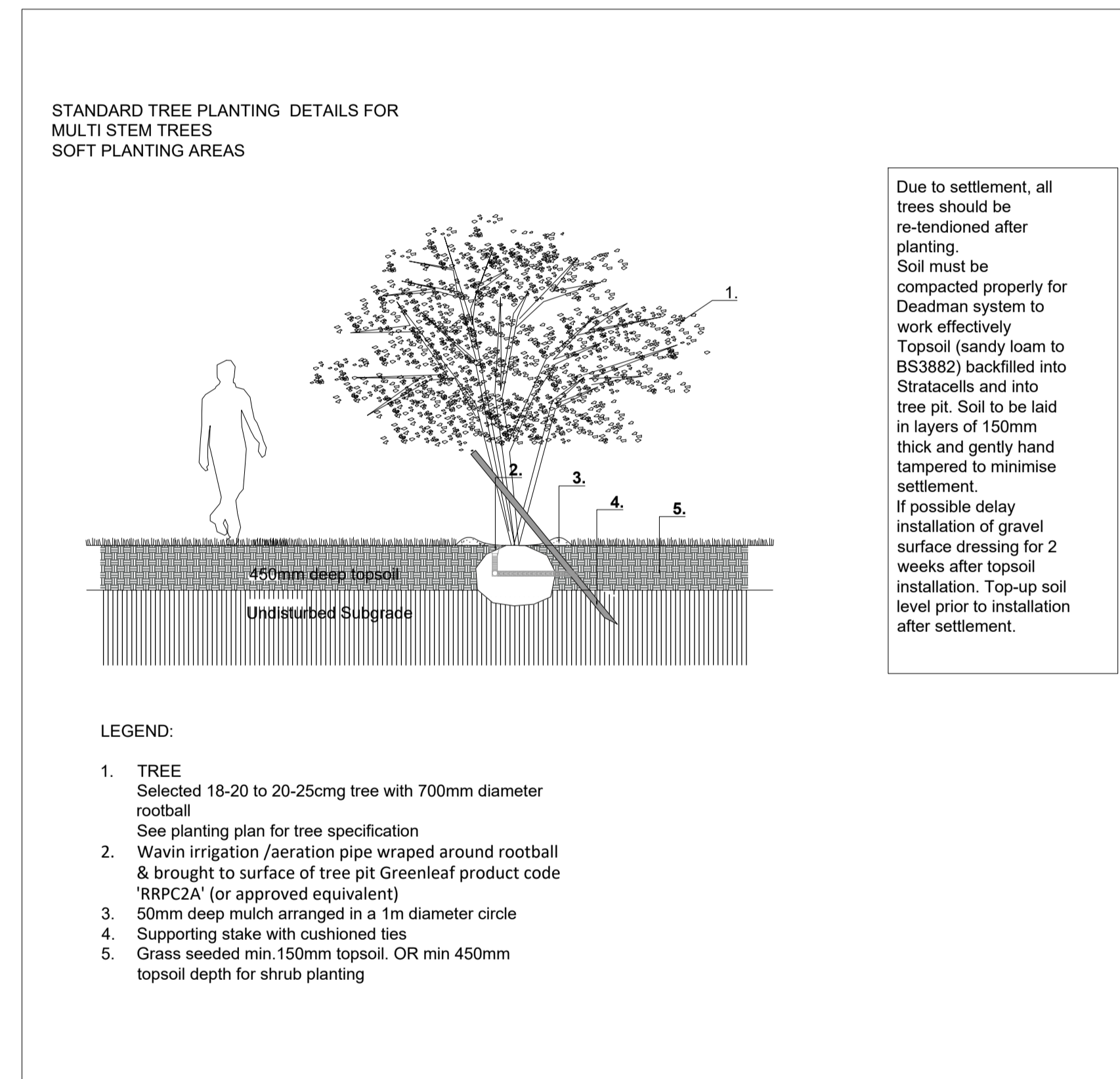
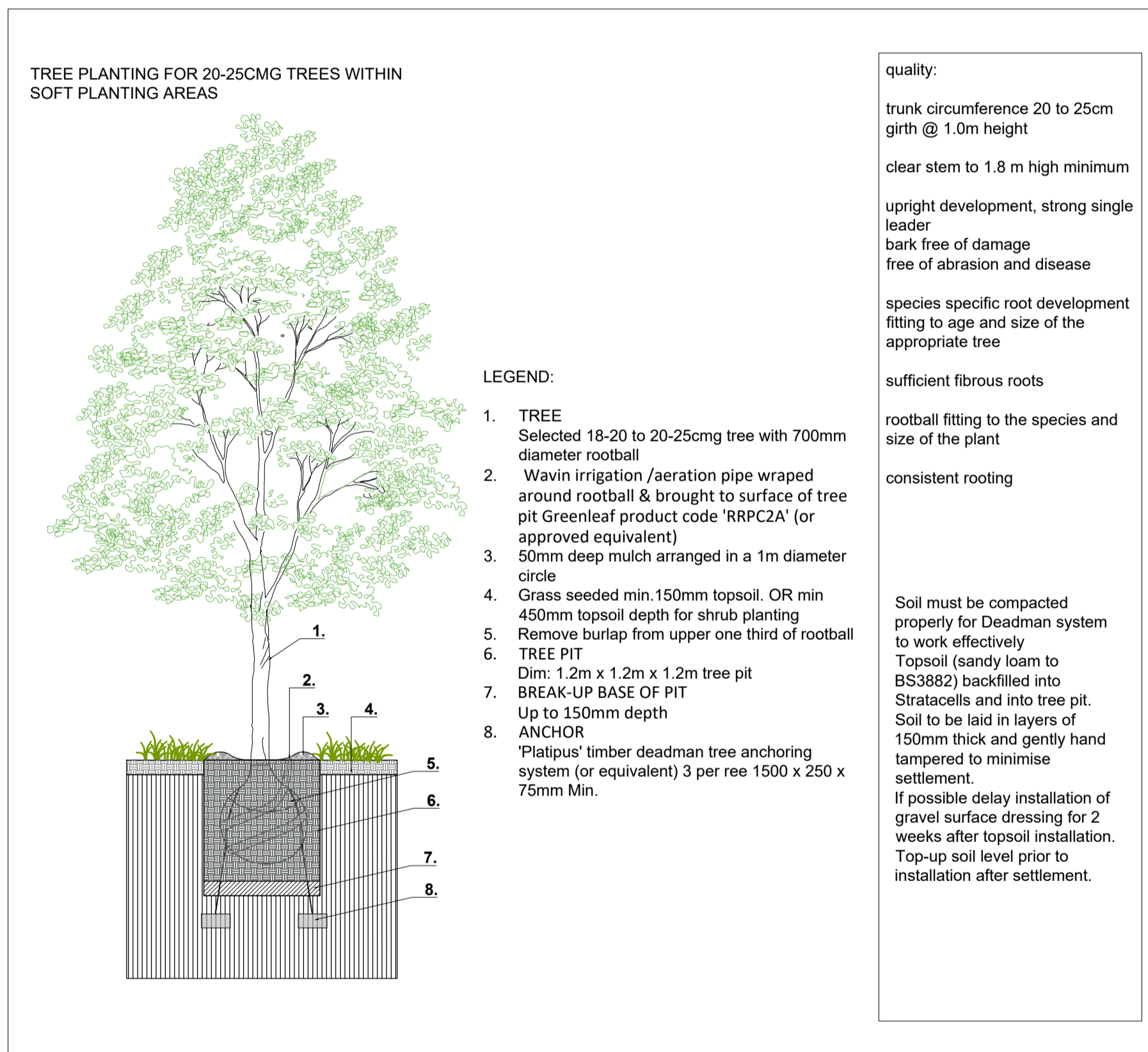
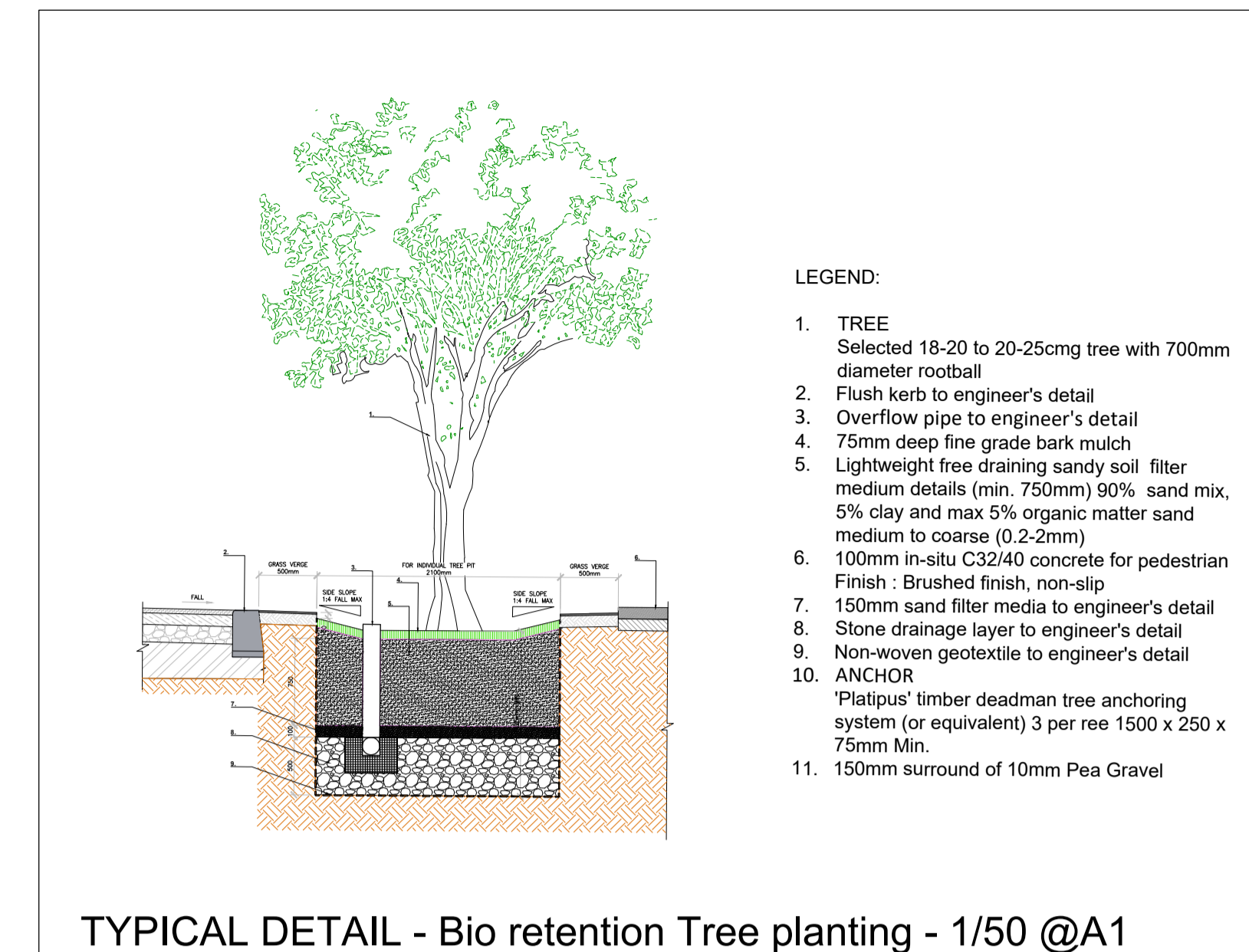

TYPICAL DETAIL - Shrub planting - 1/50 @A1

TYPICAL DETAIL - Grass and meadow planting - 1/50 @A1

TYPICAL DETAIL - Green roof detail - 1/10 @A1

REV	DESCRIPTION	DATE

PROJECT TITLE:
Social Housing Bundle 4
CLIENT:
Dublin City Council
DRAWING NAME:
SSD - Typical details
DRAWING NUMBER:
SHB4-SSD-DR-MAL-L-P3-0002
JOB NUMBER:
LSOC003

DRAWN BY	CHECKED	DATE
Andres Echeverry	FP	19.08.2024
STATUS:	SCALE:	REVISION
PART 8	AS @ A1	P00

NOTES:
All dimensions are in millimeters unless otherwise stated and shall be checked and confirmed by the contractor on site. Any discrepancies shall be immediately reported to the landscape architects. Work to figured dimensions only - Do not scale from drawing. Do Not Scale. Use Figured Dimensions Only. Not for Construction Purposes unless Specifically Marked.